

TANDBERG

TCD 320

Circuit Diagram

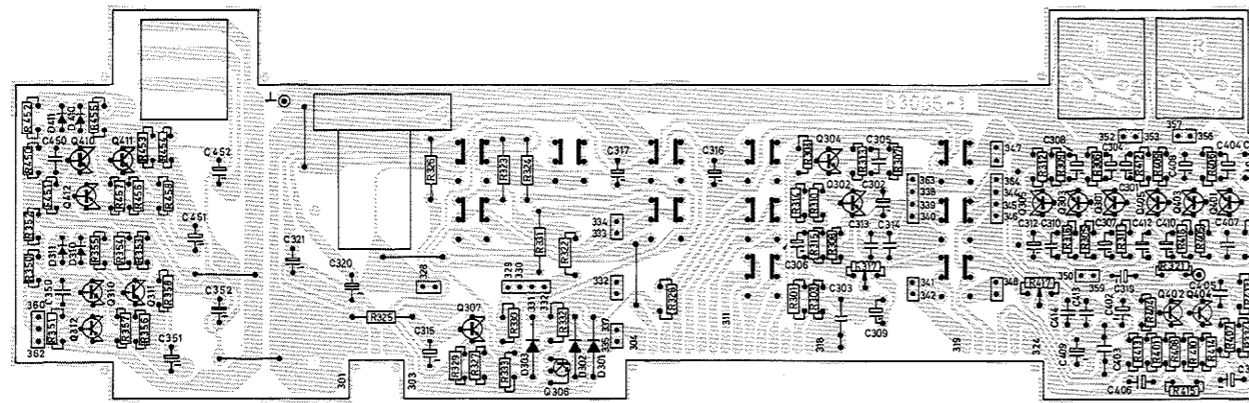



Amplifier I Board

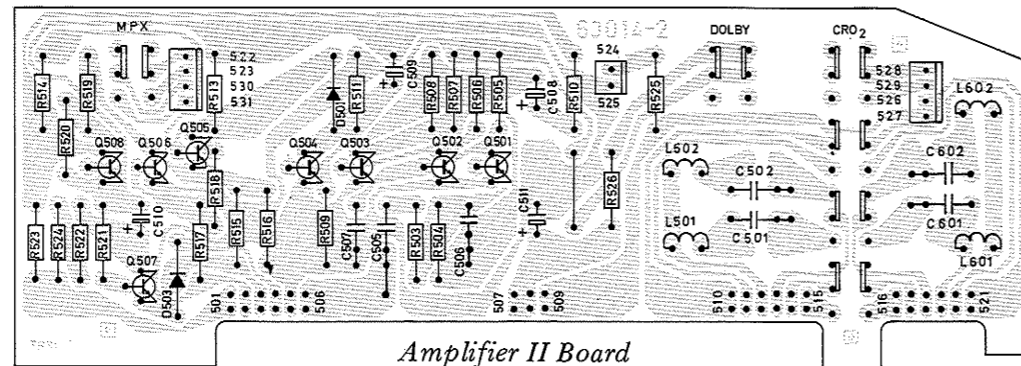

Amplifier II Board

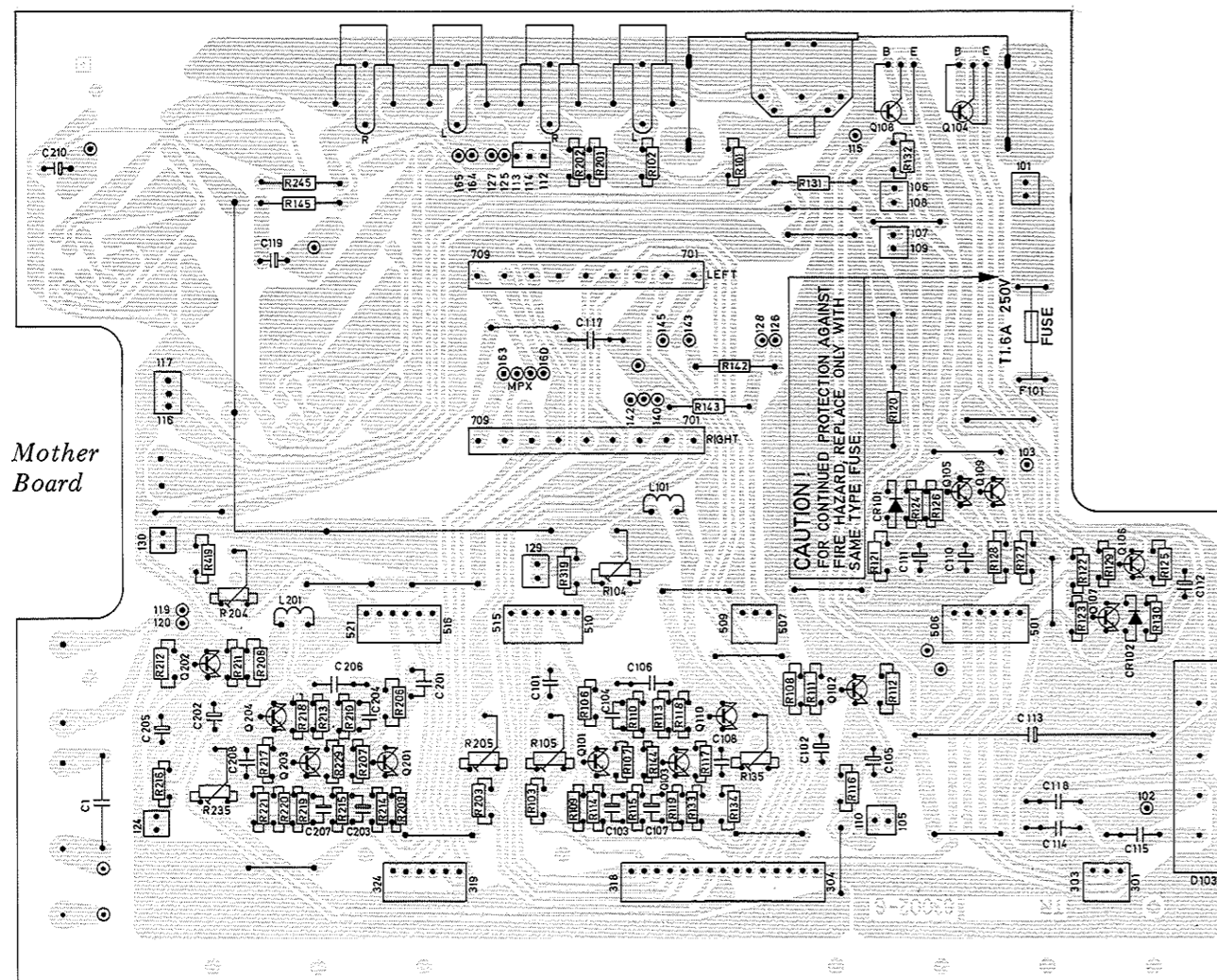

Mother Board

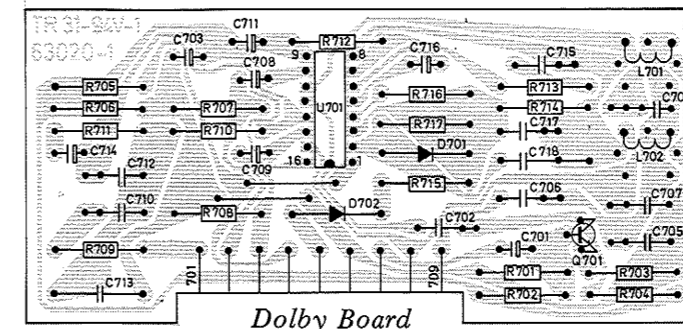

Dolby Board

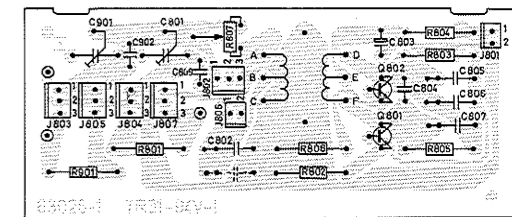

Osc. Board

ELECTRICAL CHECKS AND ADJUSTMENTS FOR TCD 320

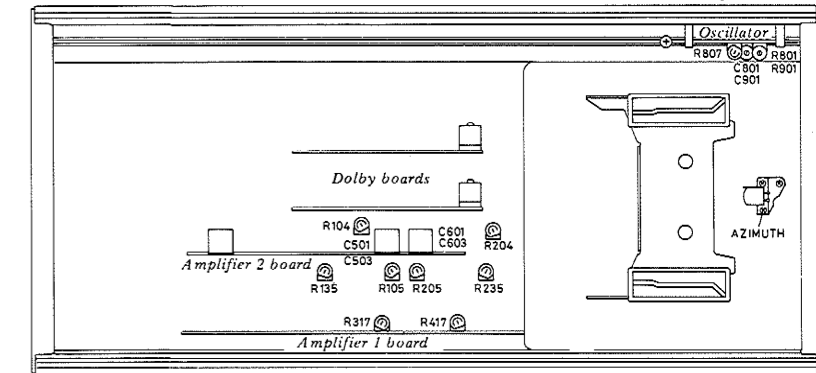

Location of test points and adjustable components

General

- "0 dB" level is defined as 775 mV. Thus - 5 dB equals 450 mV and - 40 dB equals 7.7 mV.
- Make the adjustments in the order in which they are listed here. Many of the adjustments require that previous adjustments have already been correctly made. It is especially important that adjustment for Maxell UD XL II tape (Tape button depressed) be made *before* adjustment for Maxell UD XL I tape (Tape button released).
- Clean and degauss the tape path before and after the adjustments. It is assumed that the tape path has already been correctly adjusted as described in the Service Manual for the TCD 310 (ordering No. 715105).

Necessary equipment

- 2 high impedance voltmeters (do NOT use universal meters).
- Frequency counter.
- Audio generator.
- Distortion meter.
- Wow meter (required for wow test only).
- Special noise measuring meter (see table, step 3.6).
- Tandberg test tapes No. 21 (1000 Hz speed test), No. 22 (3150 Hz wow test), No. 23 (6300 Hz azimuth test), and No. 24 (1000 Hz playback level).
- Maxell UD XL II or equivalent.
- Maxell UD XL I or equivalent.

No.	Adjustment or check	Tape	Set the cassette deck to	Measuring instrument	Measure at	Correct reading	Adjust	Comments
1	Record/playback head azimuth	No. 23	Playback	Voltmeters	OUTPUT sockets	Maximum output signal. Difference between the tracks: < 3 dB	Azimuth screw on head	Adjust to best compromise.
2	Playback level	No. 24	Playback	Voltmeters	OUTPUT sockets	775 mV	R317 (left channel) R417 (right channel)	
3	Tape speed	No. 21	Playback	Frequency counter	OUTPUT socket	± 1% (990 - 1010)		
4	Wow	No. 22	Playback	Wow meter (according to DIN 45507)	OUTPUT socket	≤ 0.15% (DIN 45511 peak weighted) Record/playback: ≤ 0.2%		Measure at end of tape. Measure both in vertical and horizontal position.
5	Oscillator frequency	Maxell UD XL II	Tape - Type II Recording	Frequency counter	Connect inductively to erase head (see comments)	80 - 100 kHz		Connection is made with a coil or a few turns of ordinary wire. Instead of a frequency counter a long-wave receiver (tuned to 3rd. harmonic) can be used.
6	Oscillator crase voltage	Maxell UD XL II	Tape - Type II Recording	Voltmeter	Across erase head	28 - 32 V		
7	Oscillator	Maxell UD XL II	Tape - Type II	Voltmeters	OUTPUT	≤ 2 mV		INPUT sockets open.

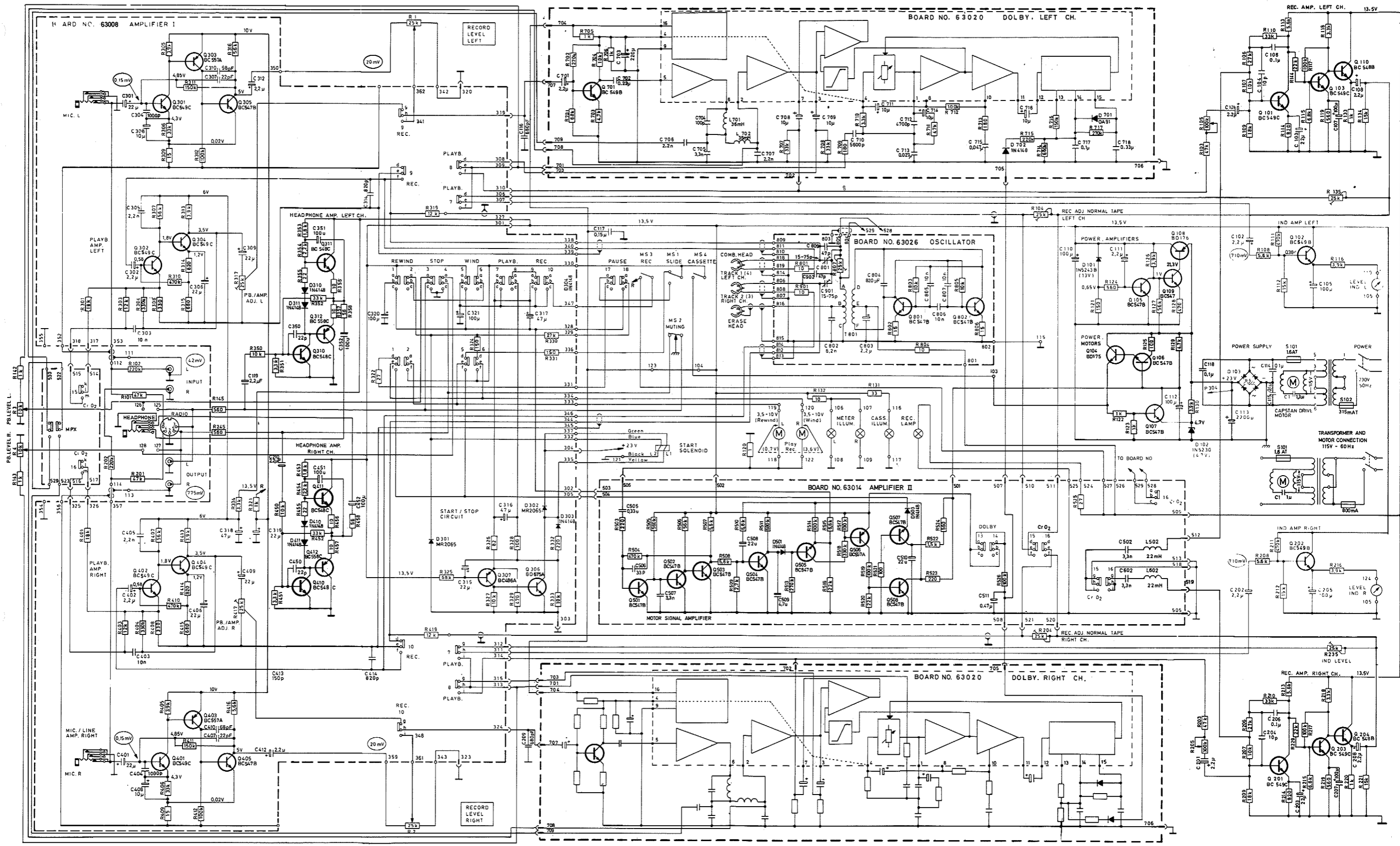

All voltages are measured with V.T.V.M. with input impedance min. 10M ohms. All DC voltages measured without signal.

(1mV) Denotes signal voltages (1000Hz); 1mV Denotes DC voltages (10V) Denotes voltages in operated mode

L: Left channel (Track 1 or 4)
 R: Right channel (Track 2 or 3)
 →: Connector
 ○1: Connection terminal

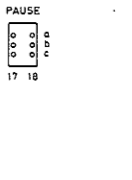
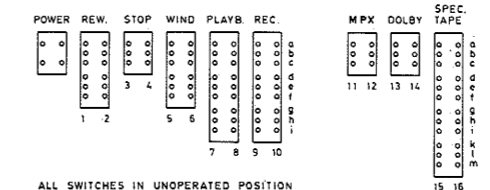
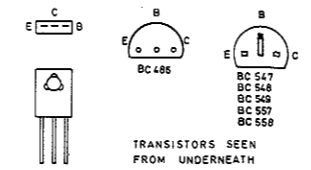

ADJUSTMENT FOR Maxell UD XL II (Tape button depressed)

No.	Adjustment or check	Tape	Measuring instrument	Measure at	Procedure
2.1	Bias (preadjustment)	Maxell UD XL II	Voltmeters	R801 (left channel) R901 (right channel) see "location drawing"	Set the cassette deck to Tape - Type II recording and adjust C801 (left channel) and R901 (right channel) to readings of approximately 6 - 8 mV. (Measure between ground and the side of the resistor which is connected to the head.)
2.2	Recording level	Maxell UD XL II	Voltmeters	OUTPUT sockets	Set the cassette deck to Tape - Type II recording. R1 and R2 to mid-position. Connect an audio generator to the INPUT sockets. Adjust the generator to 400 Hz, - 5 dB (= 450 mV on the voltmeters). [- 5 dB is used instead of 0 dB in order to avoid inaccurate results caused by varying tape characteristics.] Rewind and play back. The voltmeters should now read - 5 dB (= 450 mV) \pm 0.5 dB. If outside the tolerance, make a new recording while adjusting R105 (left channel) and R205 (right channel) as required. Then play back and check once more.
2.3	Overall frequency response (adjustment)	Maxell UD XL II	Voltmeters	OUTPUT sockets	Set the cassette deck to Tape - Type II recording. Adjust the generator to - 40 dB (= 14 mV on the voltmeters) and record a 400 Hz and a 10,000 Hz signal at this level. Rewind and play back. Use the 400 Hz signal as a reference and check on both channels that the 10,000 Hz signal is within the following tolerance: - 0 dB to + 5 dB. If outside the tolerance adjust C801 and C901 (bias). Then make a new recording, play back and check once more.
2.4	Distortion	Maxell UD XL II	Distortion meter	OUTPUT sockets	Set the cassette deck to Tape - Type II recording. Generator to 1000 Hz, 0 dB (= 775 mV on the voltmeters). Rewind and play back. Check that the distortion is \leq 3%. If outside the tolerance adjust C801 and C901 (bias). Make a new recording, play back and check once more. Then repeat step 2.3.
2.5	Erasure	Maxell UD XL II	Voltmeters	OUTPUT sockets	Record a 1000 Hz, 0 dB signal. Rewind and erase. Then rewind once more and play back the erased piece. The voltmeters should read < - 65 dB, selective measured.
2.6	Signal/noise	Maxell UD XL II and UD XL I		OUTPUT sockets	The signal/noise ratios at 3% distortion should be at least as good as specified. Measure with the Dolby NR and Tape buttons depressed. IEC A* \geq 65 dB Lin. RMS \geq 55 dB
2.7	Overall frequency response (check with Dolby NR button depressed) MPX-FILTER switch to OFF!	Maxell UD XL II	Voltmeters	OUTPUT sockets	Set the cassette deck to Tape - Type II, DOLBY (!) recording. Adjust the generator to - 35 dB and record the following frequencies: 400 Hz, 55 Hz, 1000 Hz, 4000 Hz, 10,000 Hz, and 14,000 Hz. Rewind and play back. Use the 400 Hz as a reference, and check that the other signals are within the following tolerance: \pm 3 dB (40 - 16,000 Hz) If outside the tolerance try changing the values of C501/C502 (left channel) and C601/C602 (right channel). Increased values give higher treble response.
2.8	Indicators	Maxell UD XL II	Indicators		Record a 400 Hz, 0 dB signal and adjust R135 (left channel) and R235 (right channel) to 0 dB deflection on both indicators.

ADJUSTMENT FOR Maxell UD XL I (Tape button released)

No.	Adjustment or check	Tape	Measuring instrument	Measure at	Procedure
3.1	Recording level	Maxell UD XL I	Voltmeters	OUTPUT sockets	Same as in step 2.2, except that the Tape button is released. If outside the tolerance adjust R104 (left channel) and R204 (right channel). DO NOT TOUCH R105 OR R205. NOTE! Adjustment of R104 and R204 will not affect the readings on the indicators of the cassette deck.
3.2	Overall frequency response (adjustment)	Maxell UD XL I	Voltmeters	OUTPUT sockets	Same as in step 2.3, except that the Tape button is released. If outside the tolerance adjust R807. DO NOT TOUCH C801 OR C901.
3.3	Distortion	Maxell UD XL I	Distortion meter	OUTPUT sockets	Same as in step 2.4, except that the Tape button is released. If outside the tolerance adjust R807. Then repeat step 3.2. DO NOT TOUCH C801 OR C901.
3.4	Overall frequency response (check with Dolby NR button depressed) MPX-FILTER switch to OFF!	Maxell UD XL I	Voltmeters	OUTPUT sockets	Same as in step 2.5, except that the Tape button is released. Tolerances: \pm 3 dB (40 - 16,000 Hz) If outside the tolerance try changing the values of C503/504 (left channel) and C603/C604 (right channel). Increased values give higher treble response.

*special noise measuring equipment required.