

# TANDBERG

## TR 2075 MkII

Ca 2700DM

Circuit diagrams and PW - boards  
Skjemaer og TL - kort



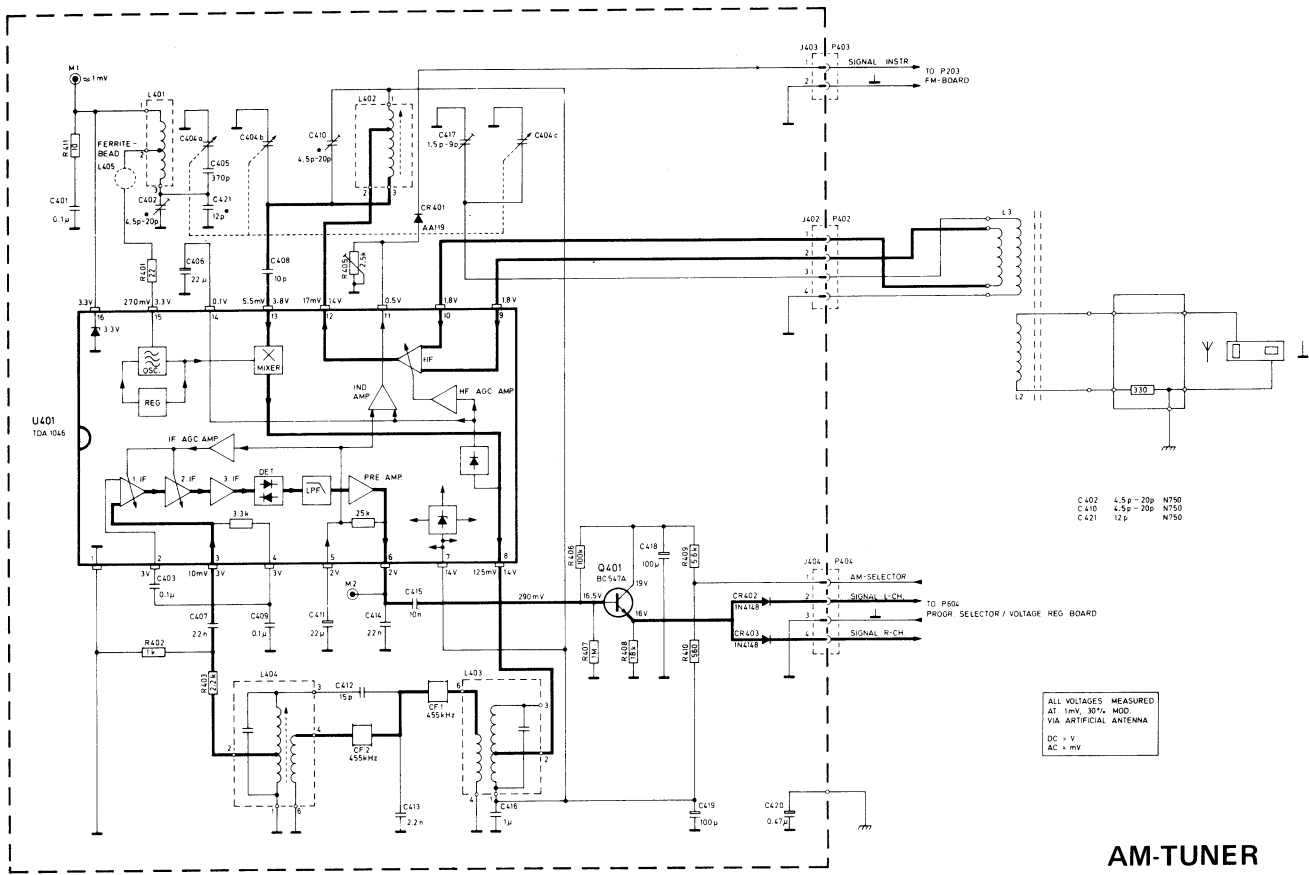

AM-TUNER

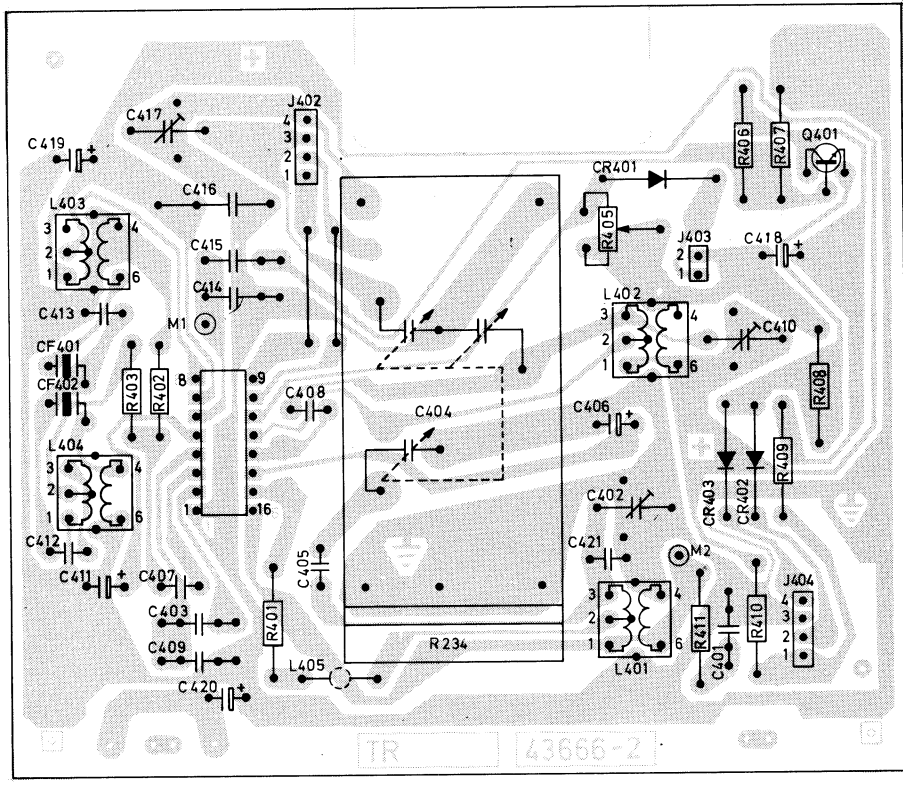

PW-BOARD, AM-TUNER  
TL-KORT, AM-TUNER

All PW-boards are seen from the solder side  
Alle TL-plater er sett fra loddessiden

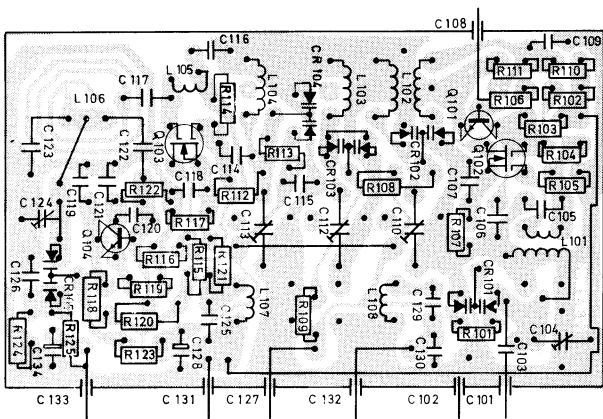
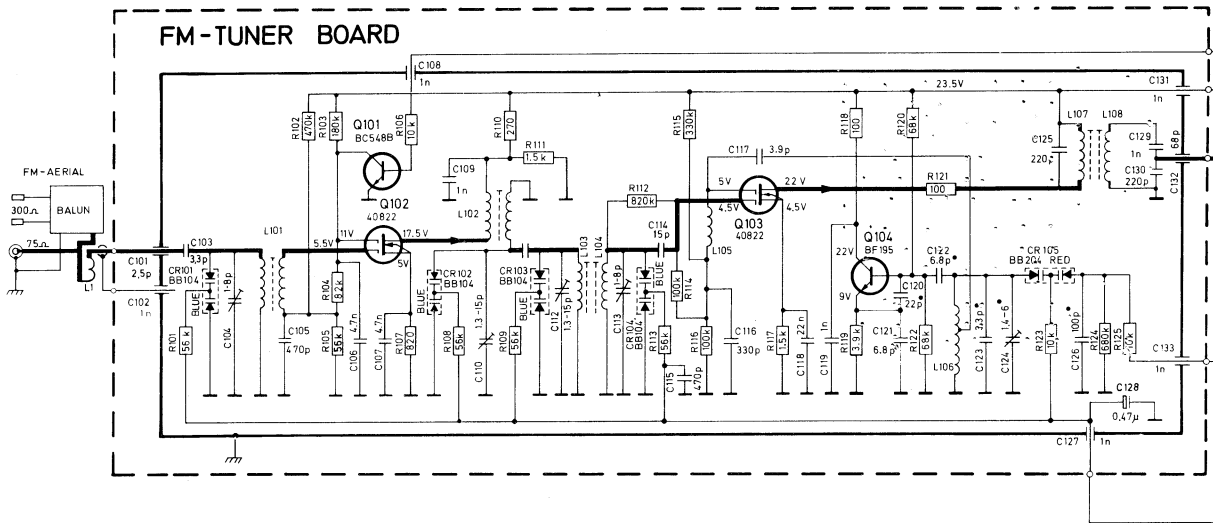

PW-BOARD, FM-TUNER  
TL-KORT, FM-TUNER

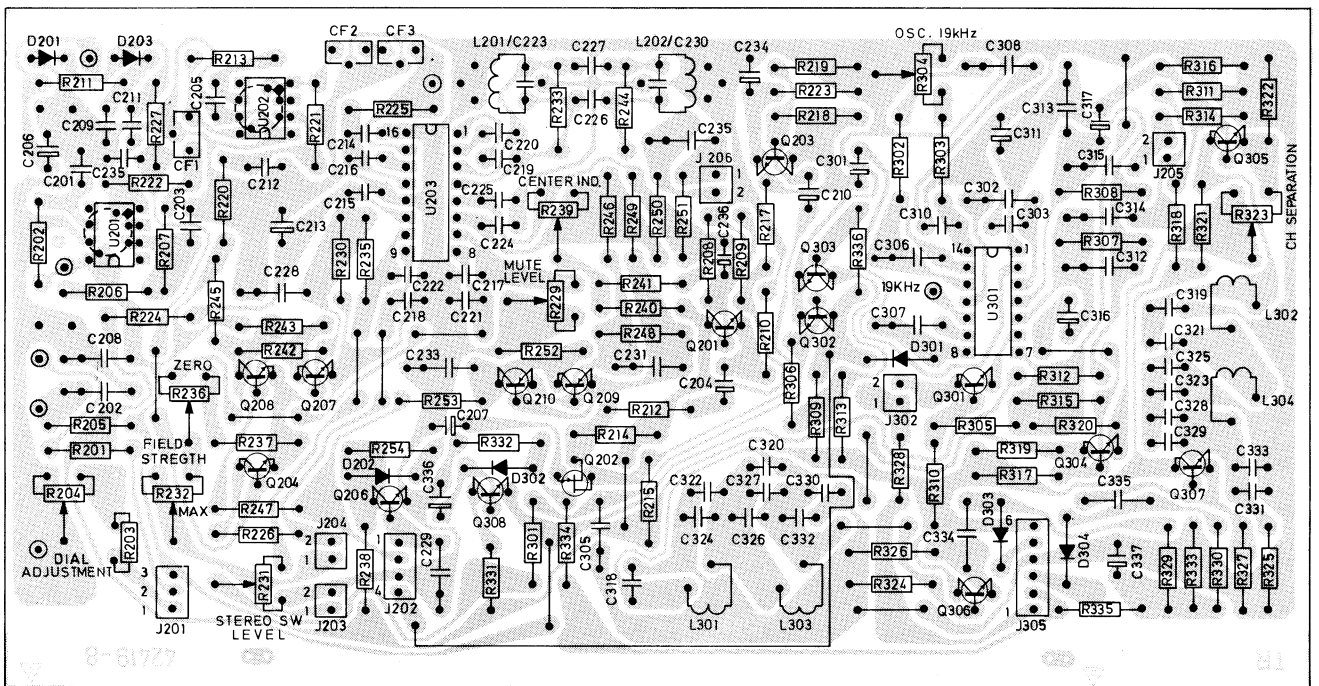

PW-BOARD, FM-IF AND DECODER  
TL-KORT, FM-MF OG DEKODER

All PW-boards are seen from the solder side  
Alle TL-plater er sett fra loddessiden

# FM-IF + DECODER BOARD

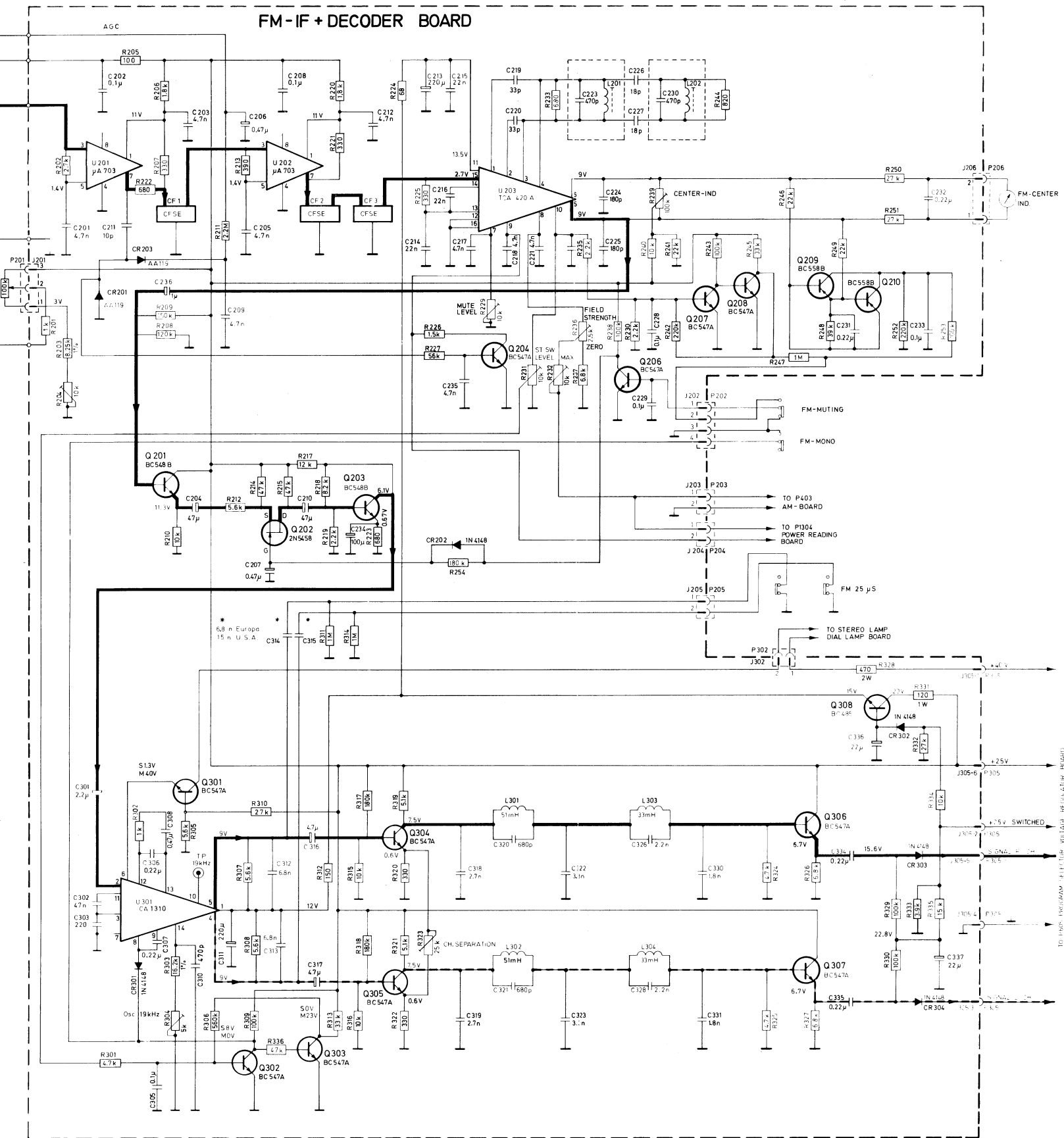

\* 6.8 n Europe  
15 n U.S.A.

- C117 3.9p N750
- C120 22p N70
- C121 6.8p N750
- C122 6.8p N750
- C123 3.3p N70
- C124 14.5p N70
- C126 100p N1500

- BC 547
- BC 548
- BC 548
- BC 481



FM - TUNER, FM IF AND DECODER  
FM - TUNER, FM MF OG DEKODER

ALL TRANSISTORS ARE SEEN FROM UNDERNEATH

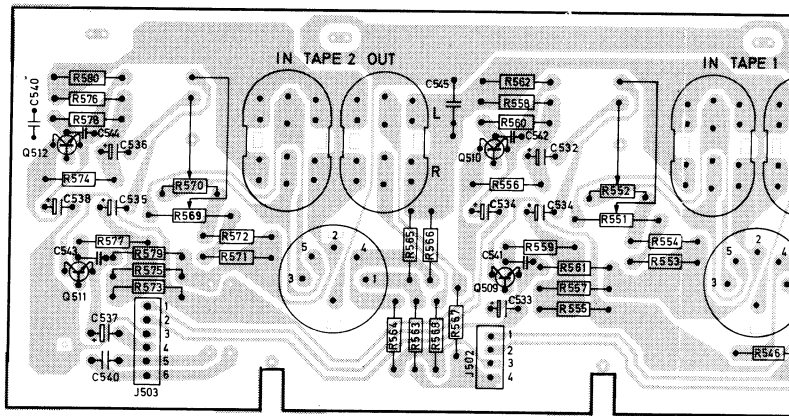

All PW-  
Alle TL

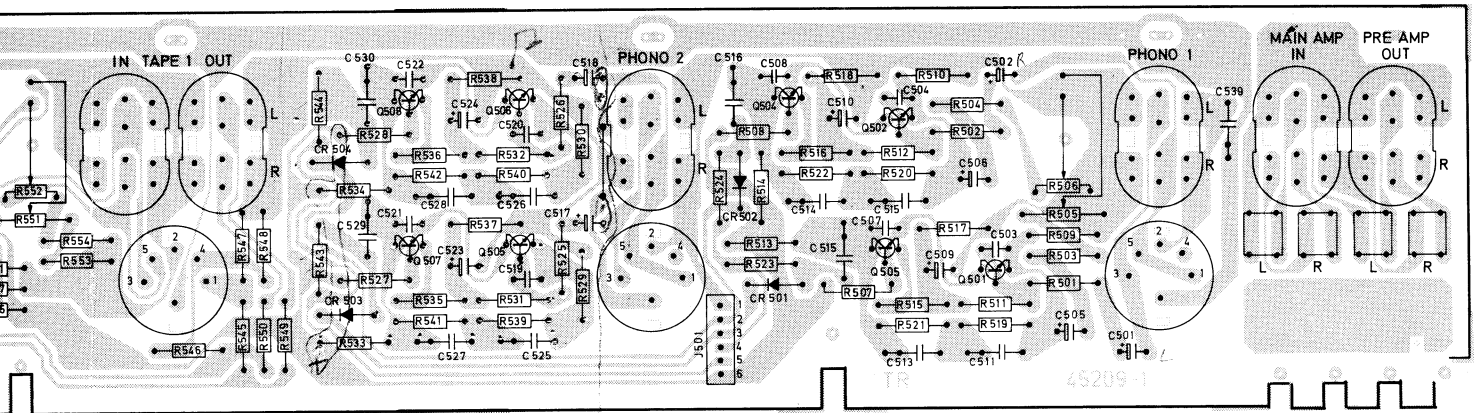

PW-BRD, RIAA-AMPLIFIER  
TL-KORT, RIAA-FORSTERKER

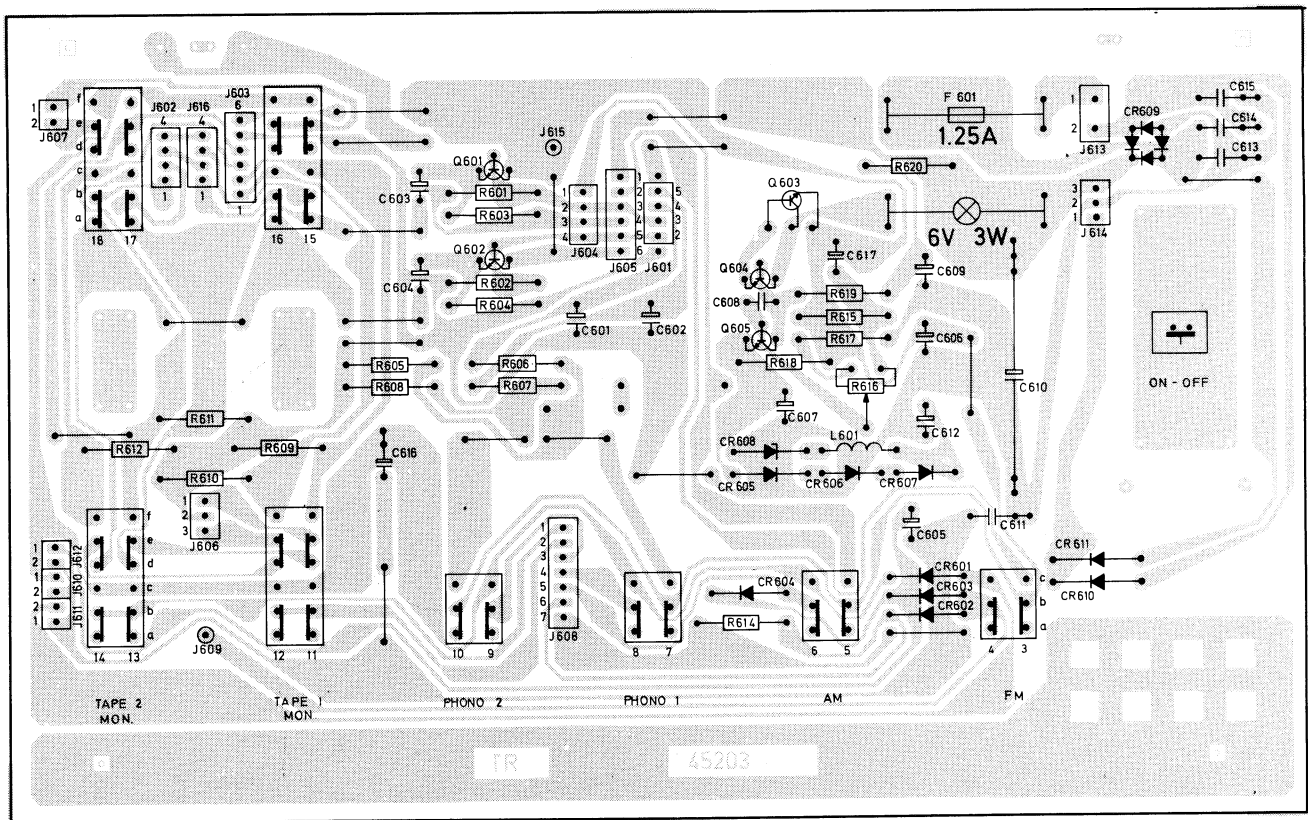

PW-BRD, PROGRAM SELECTOR  
TL-KORT, PROGRAMVELGER

All PW-boards are seen from the solder side  
Alle TL-plater er sett fra loddessiden

# RIAA / INPUT AMP. BOARD

MAIN AMP PRE AMP

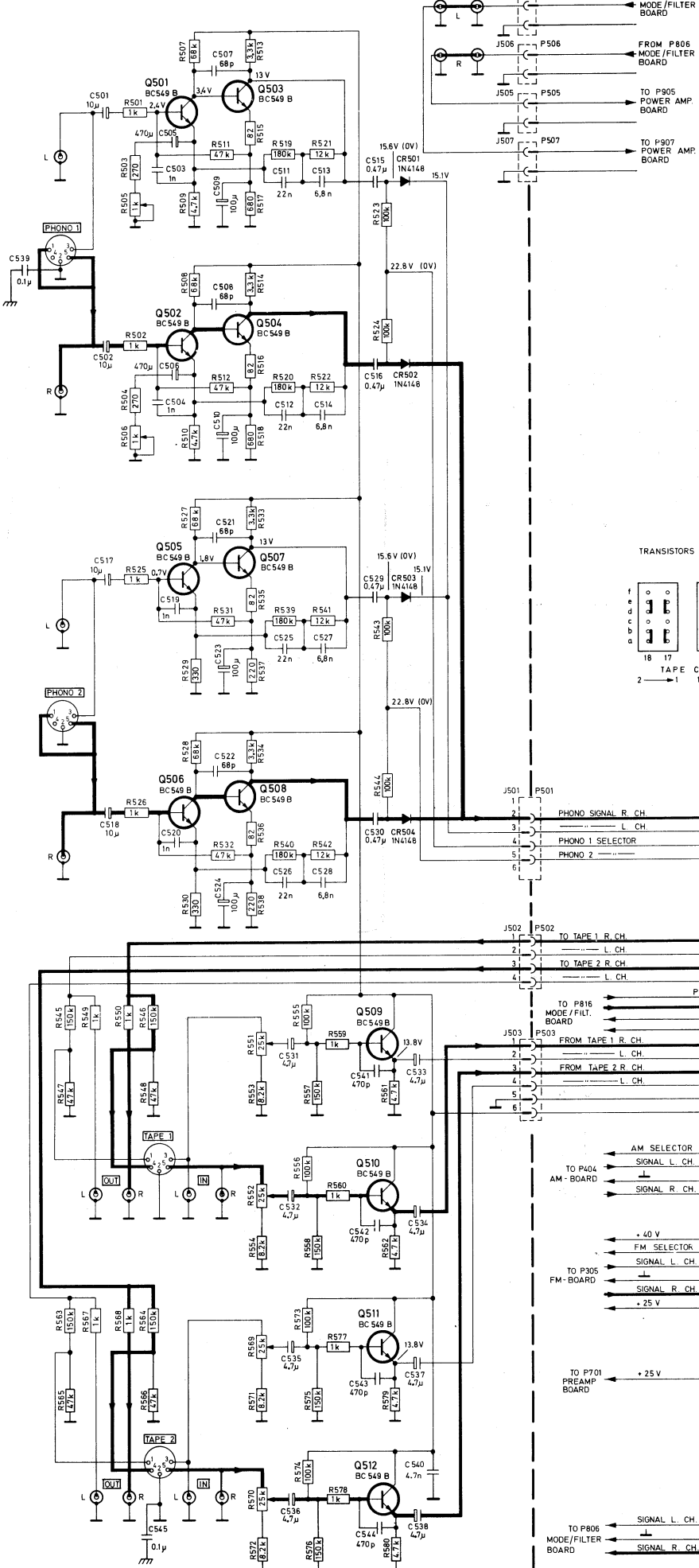

6-50000000-1, 5dB

22-16  
70V

32V

150-600  
mV



TRANSISTORS AND SELECTORS ARE SEEN FROM UNDERNEATH

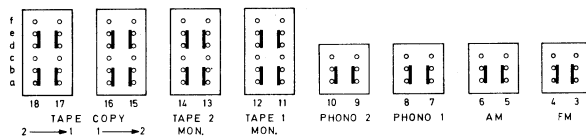

# PROGRAM SELECT./VOLTAGE REG. BOARD

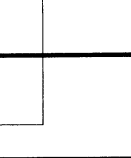
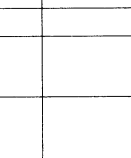
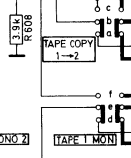
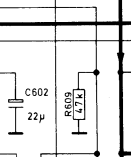
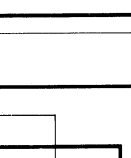
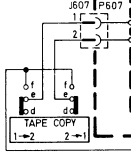
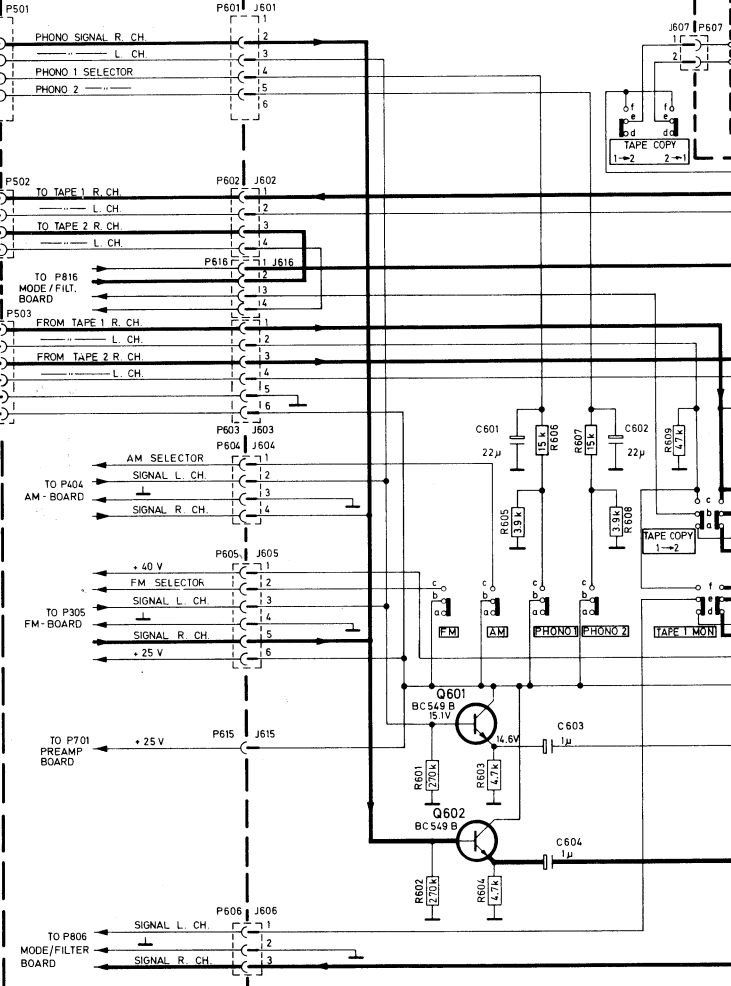

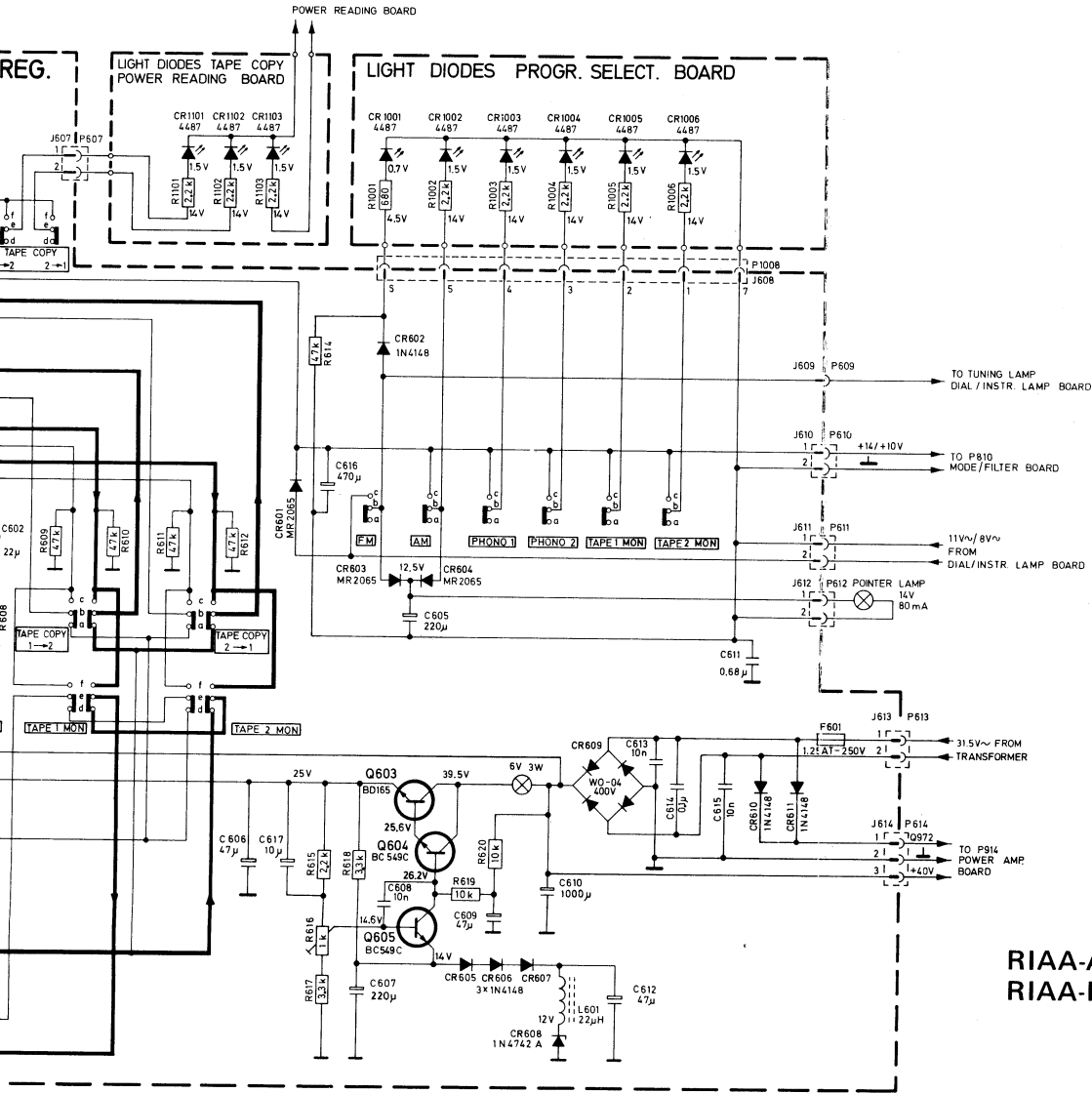



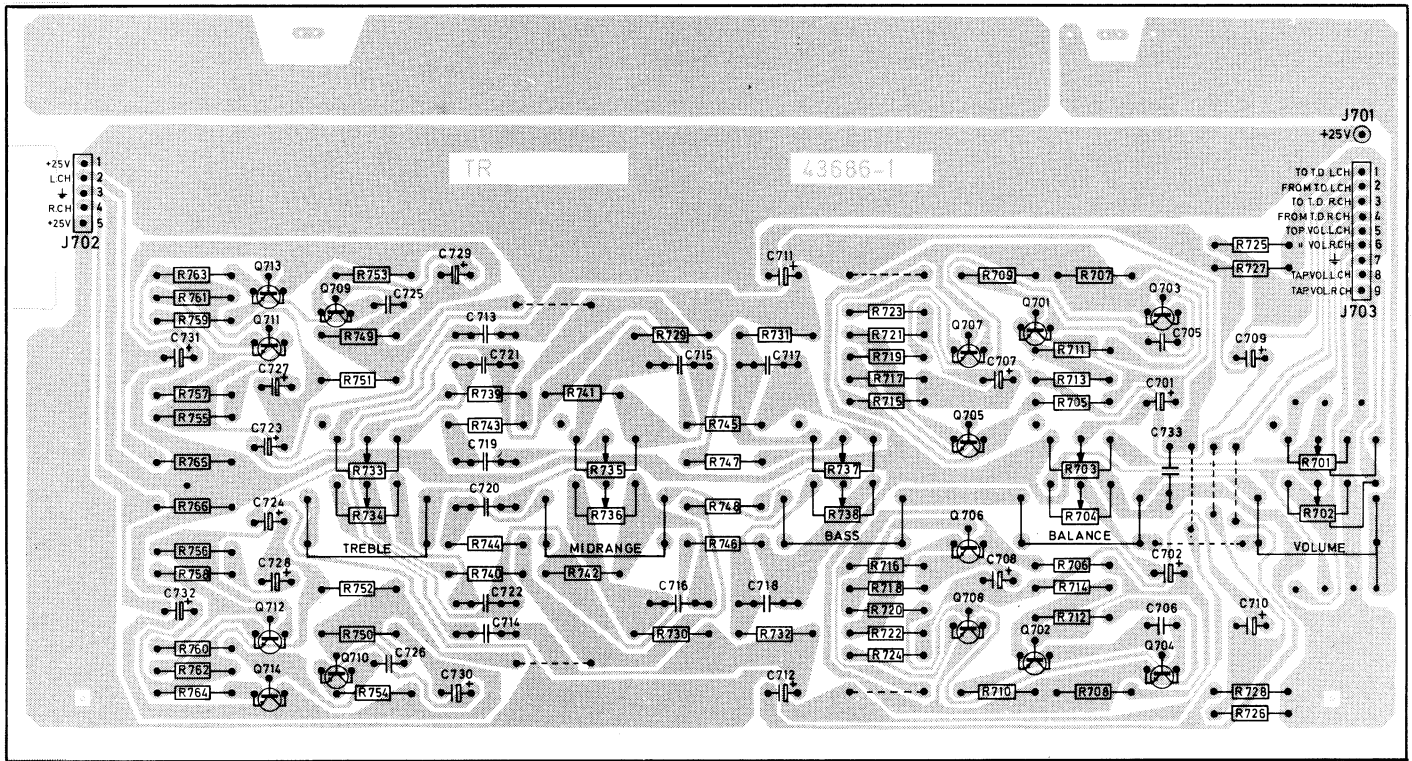

PW-BBOARD, PREAMPLIFIER/TONE CONTROL  
TL-KORT, FORFORSTERKER/TONEKONTROLL

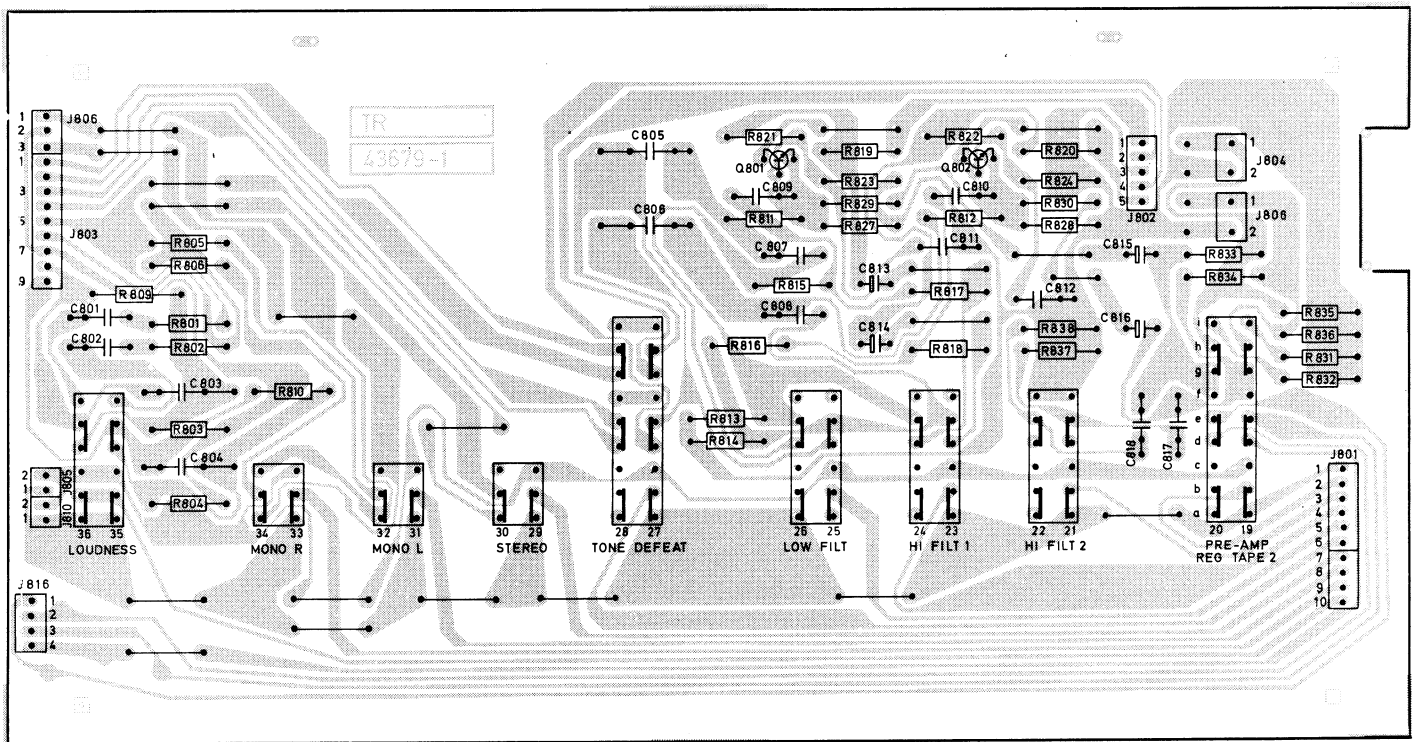

PW-BBOARD, MODE FILTER  
TL-KORT, FILTER

All PW-boards are seen from the solder side  
Alle TL-plater er sett fra loddessiden

Höhen 10kHz ± 15dB  
 Mitten 1kHz ± 2dB  
 Bässe 50Hz ± 15dB

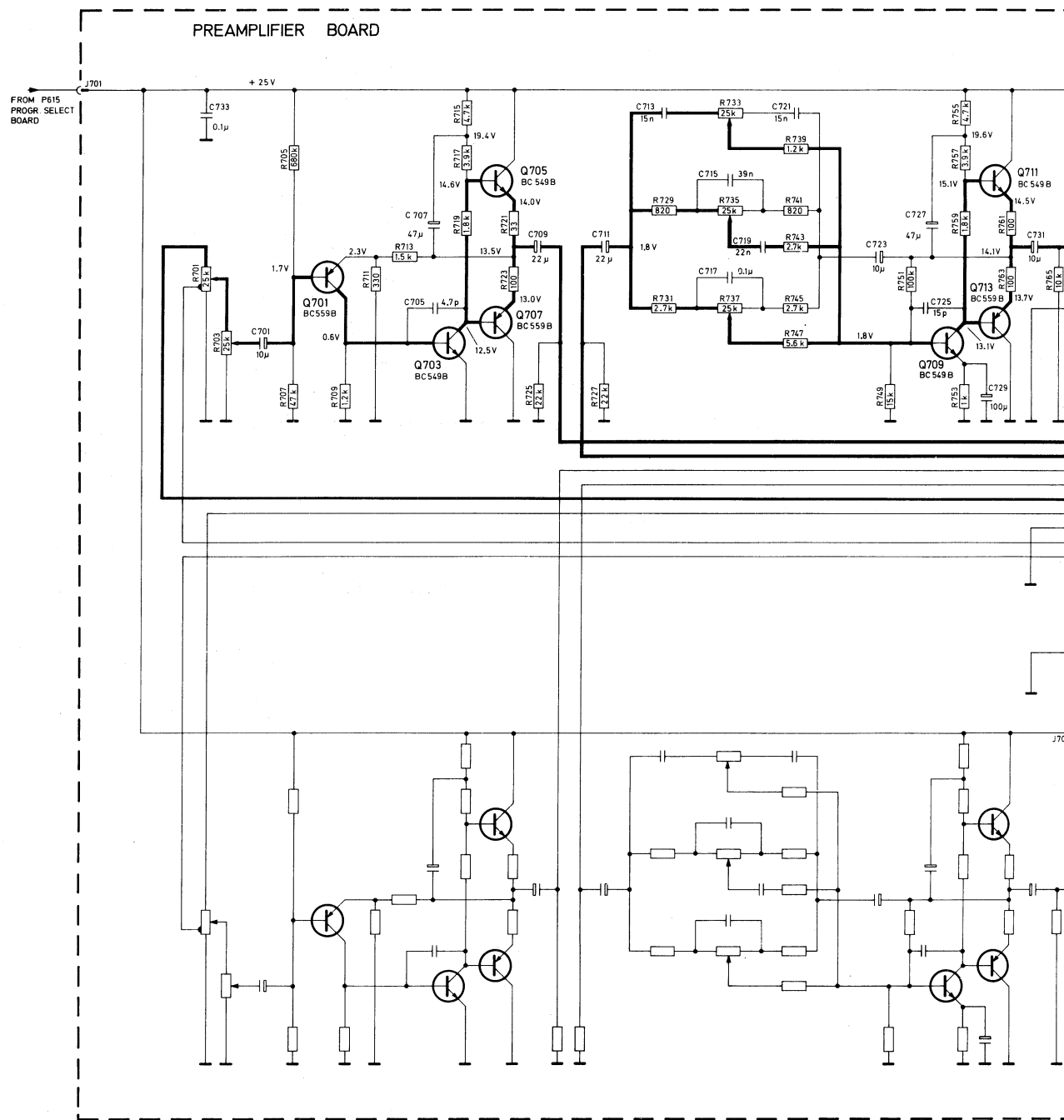



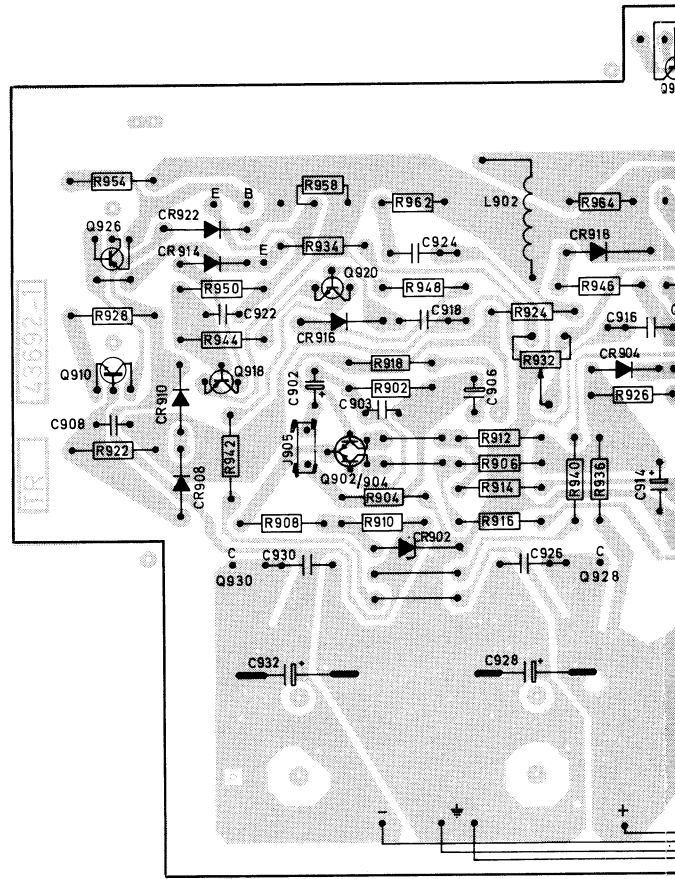

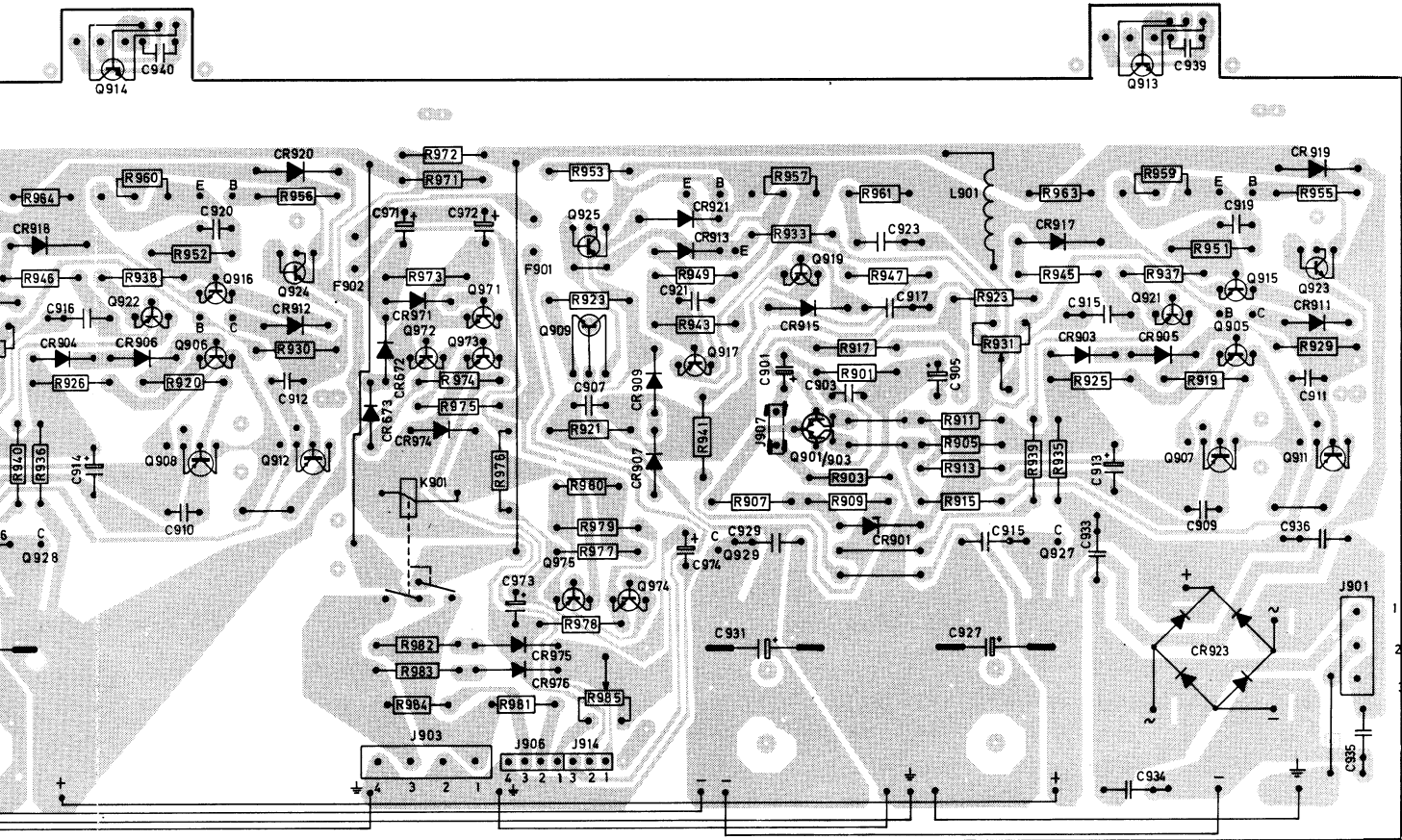

PW-BBOARD, POWER AMPLIFIER  
TL-KORT, UTGANGSFORSTERKER

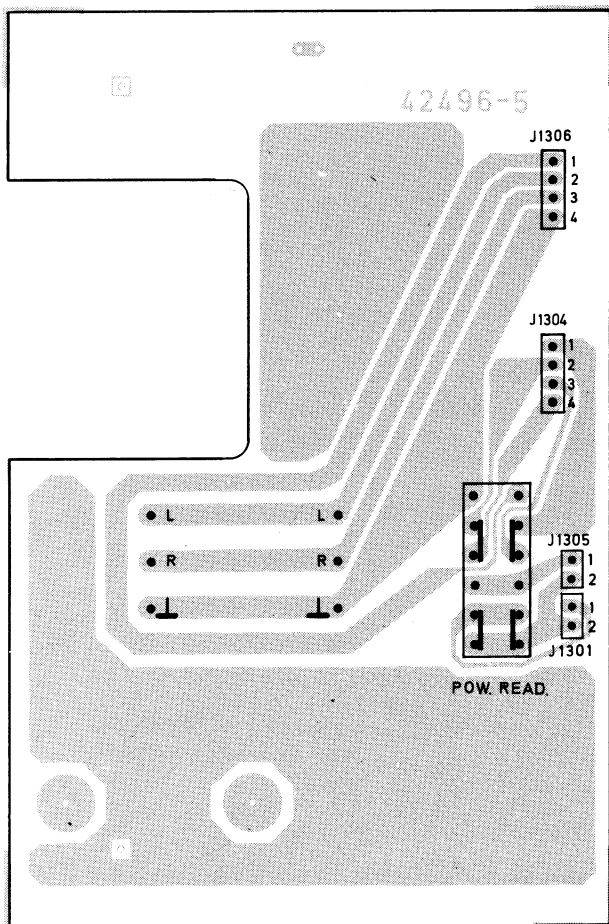

PW-BBOARD, POWER READING  
TL-KORT, EFFEKTAVLESNING

*All PW-boards are seen from the solder side  
Alle TL-plater er sett fra loddessiden*

# DIAL/ INSTR. LAMPS BOARD

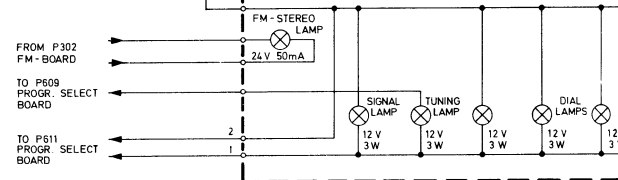

# POWER-AMPLIFIER BOARD

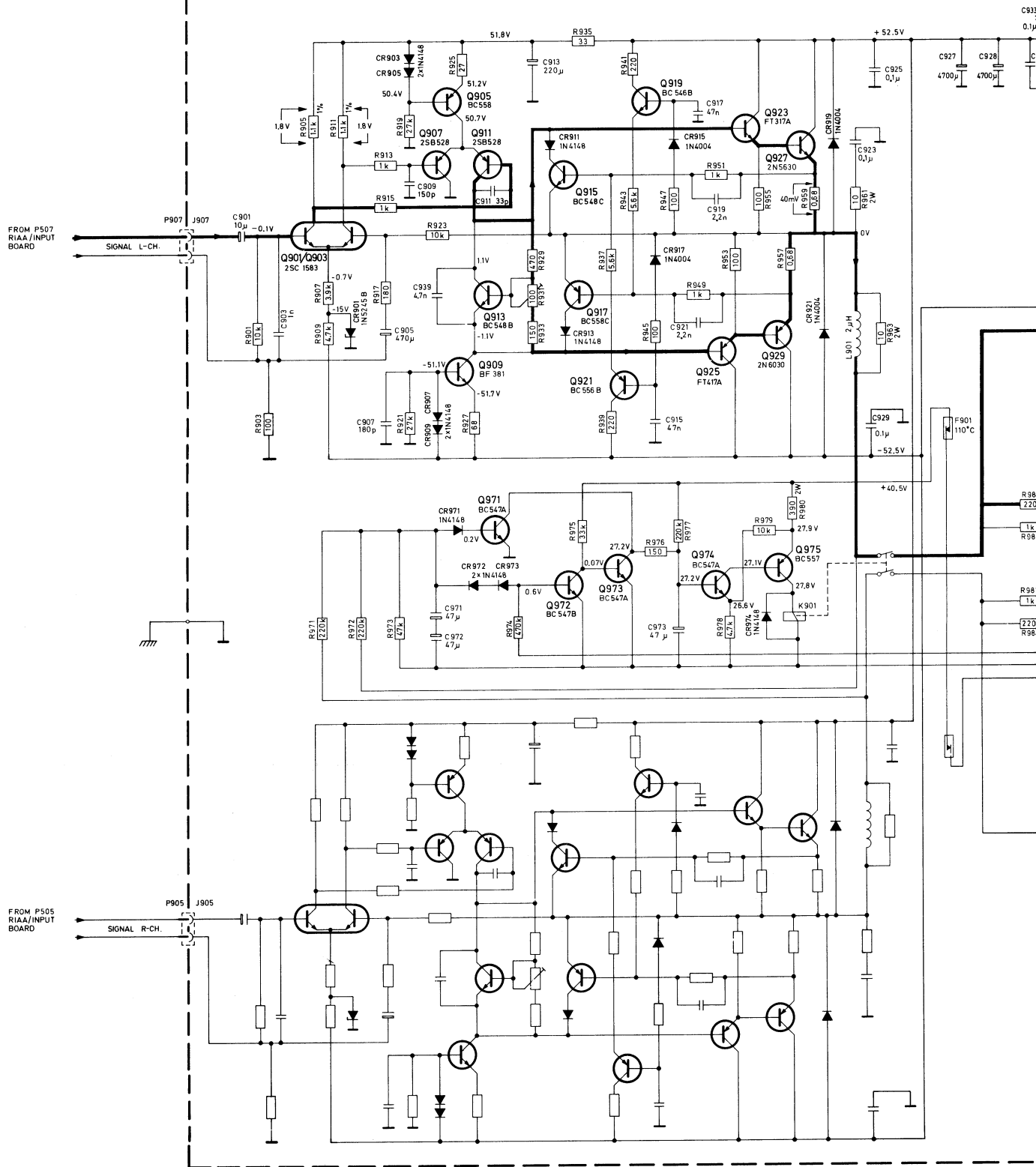

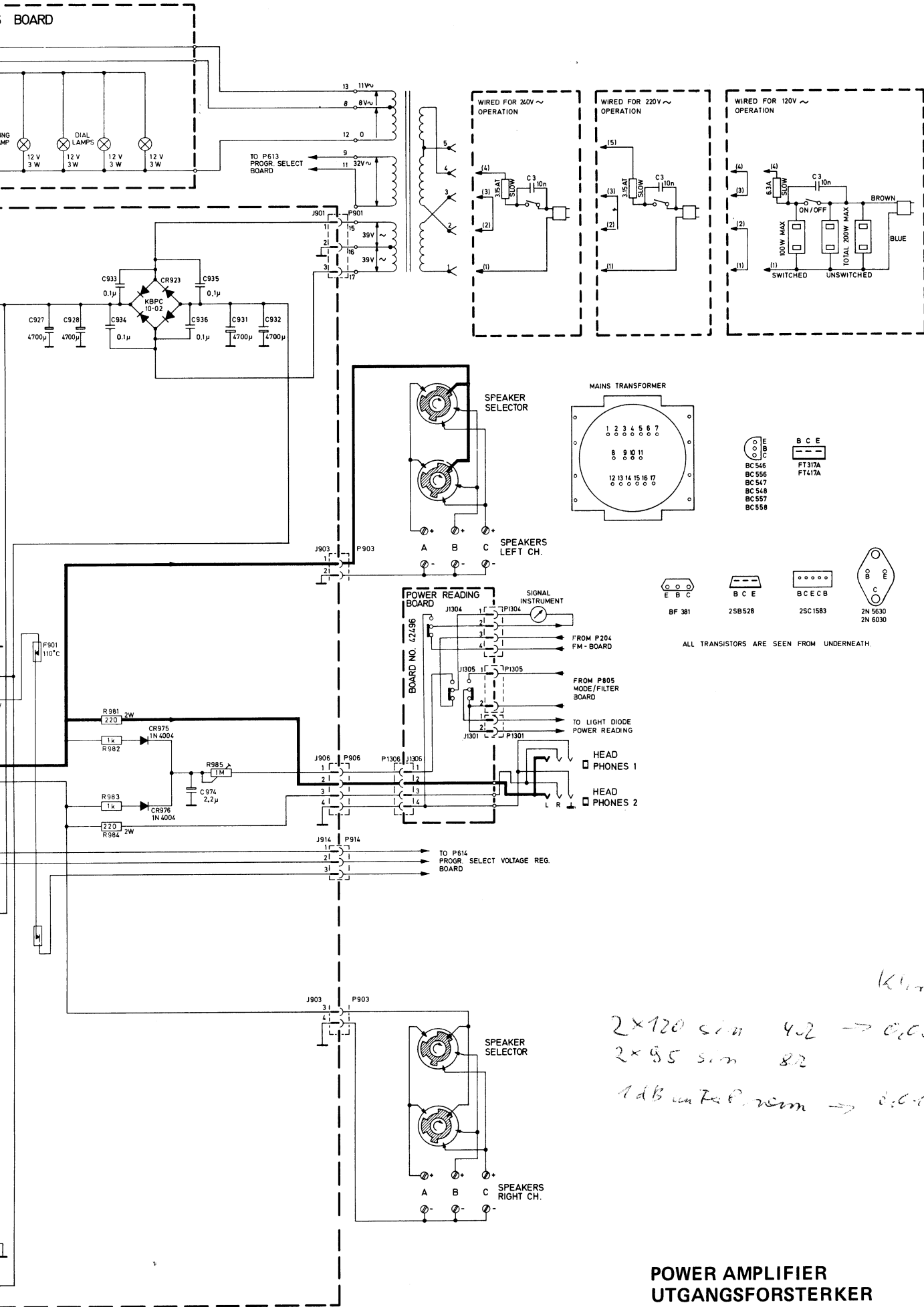

*K. L. ...*  
 2x120 sim 402 → 0.05%  
 2x95 sim 82  
 1dB unrec. norm → 0.04%

**POWER AMPLIFIER  
 UTGANGSFORSTERKER**