



TANDBERG model 9000X

Instruction Manual

TANDBERG SERIES 9000 X



Contents:	Page
Power	4
Tape	4
Preparations for use	4
End-stop	5
Counter	5
Microphone	5
Remote control	5
Connections	
Microphone	6
Tuner/amplifier	6
Headphones	7
Remote control	7
Recording	
Mono	8
Stereo	9
Playback	
Mono	10
Stereo	11
Use as a microphone preamplifier	11
Sound-on-Sound recording	12, 13
Echo	14, 15
Monitoring	16
Mixing	16
Language studies	17
Quarter-track recording and playback	17
Editing and splicing of tape	18
Degaussing	19
Cleaning of heads and tape path	19
Function diagram	20
Connecting plugs	21
Block diagram	22
Technical specifications	23, 24

Turntable with reel lock.

Head covers.

Left tension arm.

Meters for indication of program level during recording and playback.

Power pilot lamp.

Speed selector with three positions.

Power on/off switch.

MIC L and R. Microphone sockets for left and right channels.

INPUT LEVEL L and R. Adjust program level for left and right channels. The levels are indicated on record level meters.

REC SELECT L and R, selects the channel(s) to be used for recording.

HEADPHONES, socket for stereo headphones.

REMOTE CONTROL, socket for remote control unit, TANDBERG REMOTE CONTROL 9.

LINE OUTPUT L and R, phono sockets for left and right outputs.



RECORD, depress for recording.

PLAY, depress for playback.

Right hand tension arm

Counter with 4 digits.

Reset button for counter.

REWIND, depress for rewinding.

STOP, depress for stop.

WIND, depress for winding.

OUTPUT LEVEL L and R, set the output levels for left and right channels. The levels are indicated on the meters.

SOURCE/TAPE L and R. To be depressed for playback from channels L and R respectively.

S ON S, Sound-on-Sound switch.

LINE INPUT L and R, phono sockets for left and right inputs.

RADIO, 5-pins DIN-socket for recording and playback via tuner or amplifier.



Power

The machine is designed to operate from either one of the voltages 230 V, 115 V or 240 V AC, 50 or 60 Hz. Changing to a different line voltage and/or line frequency should, be carried out by a skilled serviceman. The power consumption is less than 100 watts. When power is turned on, the recorder will normally settle in stop mode. If it is desirable to start the recorder by turning power on with a timer, a TANDBERG REMOTE CONTROL 9 must be connected to the socket REMOTE CONTROL. A switch on the remote control unit will determine whether the machine starts in record or playback mode when the timer operates.

Tape

Tandberg Tape Recorder 9000 X is designed for the LH-Tape (Low Noise - High Output) which gives a favourable signal/noise ratio. LH-tape with matt backing can also be used. If, for some reason, ordinary Low Noise Tape is to be used for recording, the record level should be set for a meter reading of approximately minus 2.5 dB to achieve the best possible recording quality (maximum 3% tape distortion). Standard tape should not be used for recording, because the higher tones would not be recorded at full strength. Prerecorded tapes of all these categories can, however, be used for playback.

Preparation for use

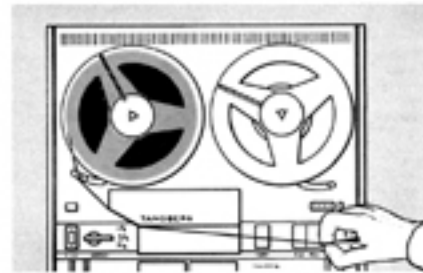

Turn the power on. The STOP button will then light. Put the tape reel on the left turntable, so that the reel rotates anticlockwise when the tape is pulled out. Place an empty reel - of the same size - on the right hand turntable. Twist the reel locks to secure the reels. This is particularly important when the machine is used in vertical position. Cut away the adhesive tape to prevent the adhesive substance from contaminating the heads.



The tape can be threaded with one hand. First, put the tape around the left hand tension arm and position the tape in the slot between the two head covers. Pull the tape around the right tension arm to the take-up turntable. Wrap up a few turns of tape by turning the reel anticlockwise. Select the tape speed. The best sound quality is obtained at 7 1/2 ips, whereas 1 7/8 ips gives the longest playing time.

Warning: Never place the recorder upside down (reels down) as this would damage the tape tension arms.

Note: Do not touch the function select buttons until the threading of the tape has been completed.

End-stop	Counter	Microphone	Remote control
<p>A photo-electric sensor in the right tape guide post will cause the machine to stop when the tape runs out or when a transparent leader tape is detected. If the machine stops on the leader, hold one of the buttons for drive, winding or rewinding depressed to run the tape off the reel. The machine will stop from drive speed within only a few inches of a transparent leader. To avoid the tape running off the reel when stopping from full winding speed, a transparent leader of at least 3ft. is required.</p> <p>Should the lamp for the end-stop sensor burn out, the recorder will still operate normally, except that it must be stopped manually at the end of the tape.</p>	<p>The counter indicates the accumulated number of revolutions for the right hand tape reel. Always reset the tape counter when a new tape is put on, and make a note of the counter reading at the beginning and end of a recording. This will make it easy to locate the recording later.</p>	<p>Microphones with impedance of 200 - 700 ohms can be used. The sensitivity of the microphone input will automatically adapt to the impedance of the microphone. Tandberg Microphone TM 5 is a dynamic microphone of high sensitivity and robust design. It is primarily intended for vocal use. The microphone is effectively protected against wind and blowing sounds, and is relatively insensitive to touching of the microphone housing.</p> <p>Tandberg Microphone TM 6 which is a dynamic microphone suitable for both speech and music, is also insensitive to wind and to touching of the microphone housing.</p> <p>These microphones are available from the Tandberg dealers.</p>	<p>Series 9000 X has the possibility for remote control of forward and reverse winding, recording, playback and stop.</p> <p>The Tandberg Remote Control 9 is a robust unit with the same function selector buttons as the tape recorder. The buttons are lit when operated.</p> <p>The function selector buttons on the tape recorder can also be used when the remote control unit is connected.</p> <p>The switch TIMED START on the control unit should normally be in OFF position except when a timer is used to turn the power on. In that case the switch should be set to either PLAY or RECORD depending on the mode in which it is desired to start the recorder.</p>

Connections

Microphone

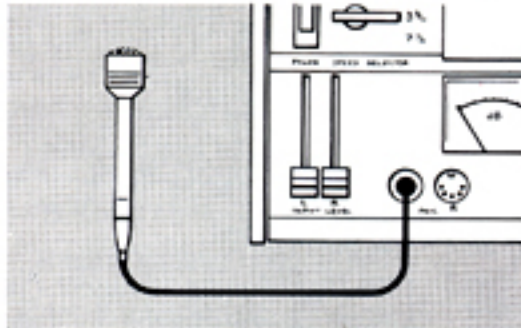

Microphones with impedance of 200-700 ohms can be plugged into the sockets MIC L and MIC R on the front of the recorder. The sensitivity of the microphone inputs is automatically adjusted for the impedance of the microphone plugged in. Program sources connected to the other inputs, must either be disconnected or switched off when microphones are used, to avoid unwanted mixing with the microphone program.

One or two microphones can be used for mono recording.

When only one of the REC SELECT

Tuner/amplifier

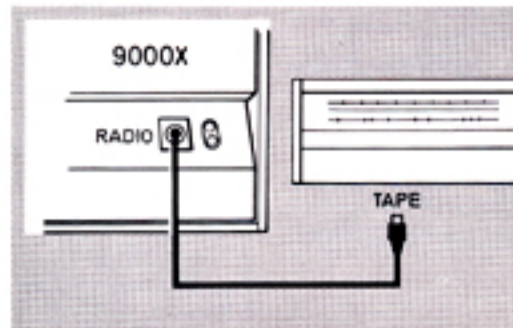

A tuner or an amplifier for recording or playback is connected to the sockets at the back of the machine (opposite the tape reels). Connect the furnished DIN cable from the socket TAPE on the tuner/amplifier to the socket RADIO on the tape recorder.

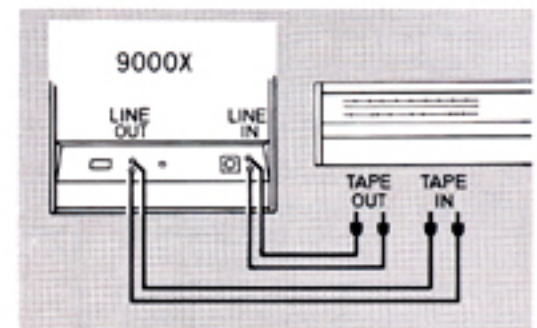

Alternatively, the tuner or amplifier can be connected with two phono leads from sockets TAPE OUT L and R on the tuner/amplifier to sockets LINE IN L and R on the tape recorder, and two phono leads from sockets TAPE IN L and R on the tuner/amplifier to sockets LINE OUT L and R on the tape recorder.

When only one of the REC SELECT buttons are depressed, the programs from all inputs will be fed to that channel. If one single microphone is used, it can be connected to either left or right microphone input as desired.

When recording in stereo, place microphones to the left and to the right of the "sound" as shown.

Headphones

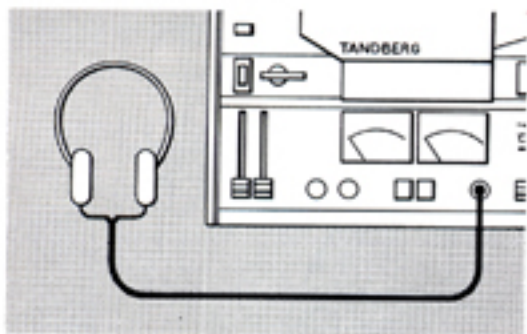

Stereo headphones can be connected to the socket HEADPHONES on the top plate. The headphone impedance should be 8 - 2000 ohms. The headphones should be disconnected when the other outputs on the machine are in use.

Copying

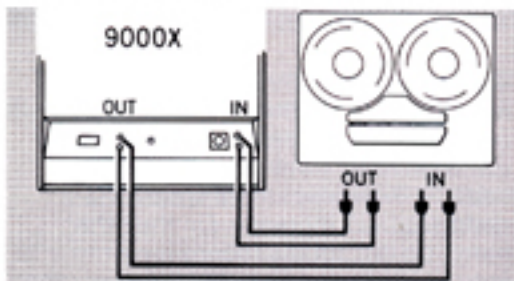
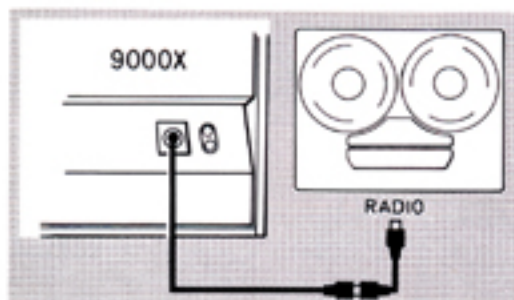

To establish the correct connections for copying, a special copying cable must be used. This cable is available from the Tandberg dealers. Alternatively, phono leads can be connected from the OUT sockets on the machine used for playback to the IN sockets on the machine used for recording.

Remote control

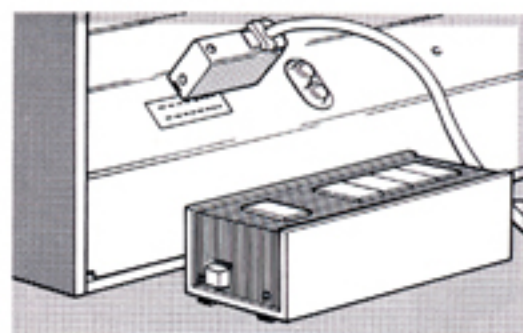

The remote control unit (Tandberg Remote Control 9) is connected to the socket REMOTE CONTROL on the connector strip at the back side (opposite the tape reels) of the tape recorder.

Recording

Mono

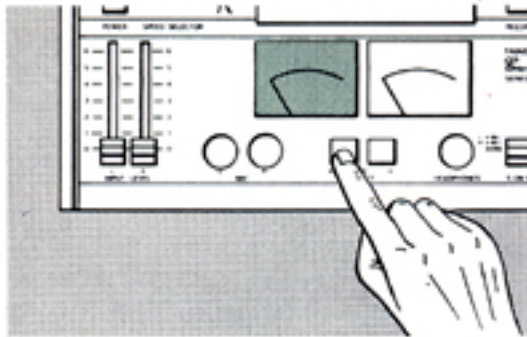

Connect microphone, amplifier or tuner as explained. In mono it makes no difference whether the program is fed to INPUT L or R.

1. Depress REC SELECT for the channel to be used for recording. The corresponding record level meter will light, indicating that the channel is prepared for recording of program from any L or R inputs.

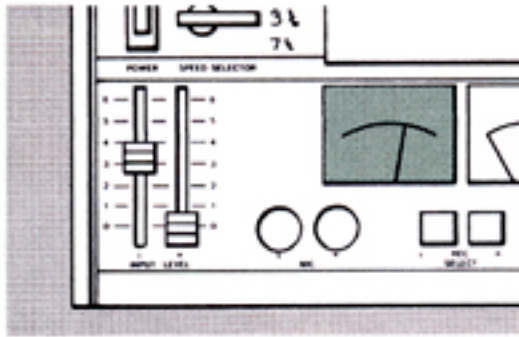

2. With the INPUT LEVEL control for the input in use, set the record level to 0 dB on the meter. Only peaks of short duration must be allowed to cause reading in the red sector where the distortion will increase. On the other hand, do not set the record level too low, as the tape noise may then become noticeable.

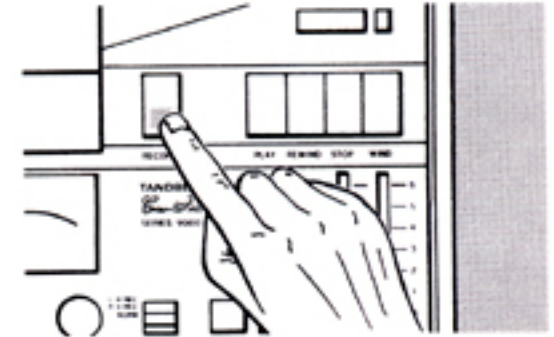

3. Start the recording by depressing the RECORD button.
4. To end the recording, depress the STOP button.

Monitoring of the recording quality is explained on page 16.

The S on S switch should be in position **NORM.**

The meters are calibrated to indicate the record level accurately. A small discrepancy between the settings of left and right controls may be required to obtain equal meter readings.

Depressing of the RECORD button has no effect unless at least one of the REC SELECT buttons has been depressed and the STOP button lights. It is therefore not possible to go direct to recording from PLAY, WIND or REWIND.

Stereo

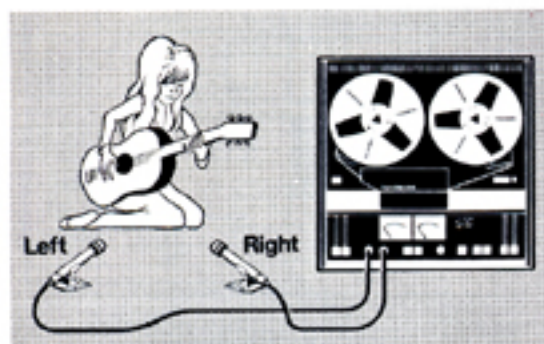

Stereo recording is performed in the same way as mono recording with the following exceptions:

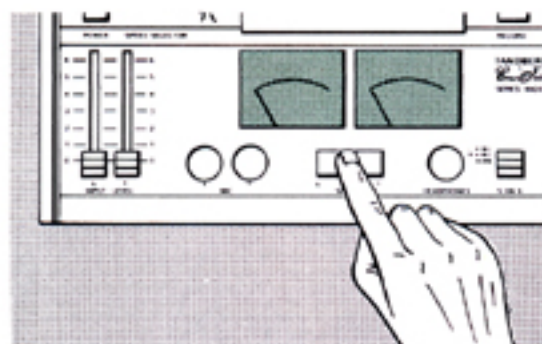

1. Depress both REC SELECT buttons. Both record level meters will then light, indicating that programs from inputs L and R will be recorded separately on the respective channels.

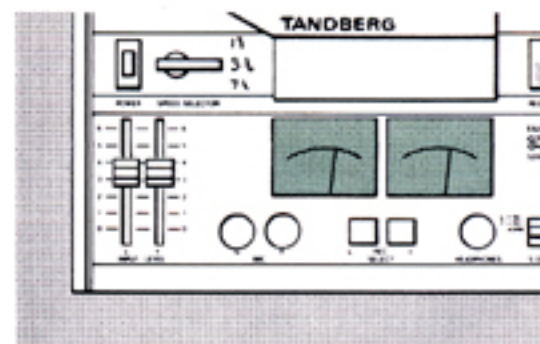

2. Adjust the record level meter for each channel with the corresponding INPUT LEVEL control.

Check the recording quality while recording by comparing the reproduced program with the program as being fed to the tape recorder. See **Monitoring**, page 16.

Playback

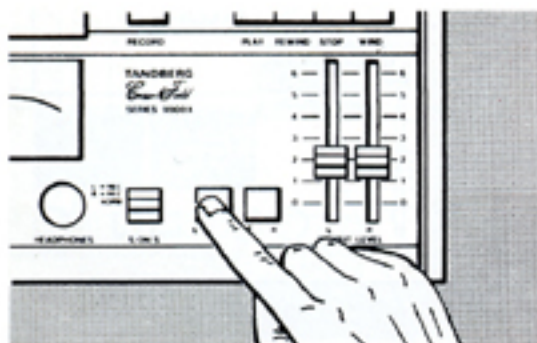

Connect amplifier or headphones as explained.

1. Depress the SOURCE/TAPE button for the channel from which playback is desired.

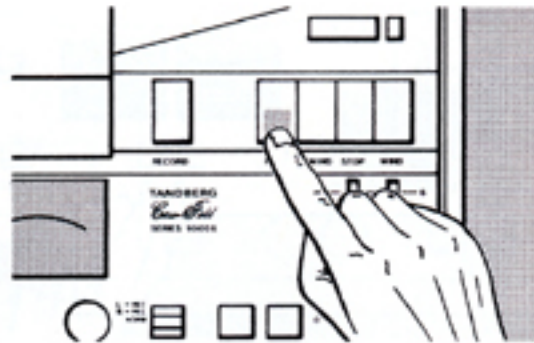

2. Start the playback by depressing the PLAY button. The reproduced program is fed to the outputs of both channels, and both meters are lit. The meters indicate the output levels in the two channels.

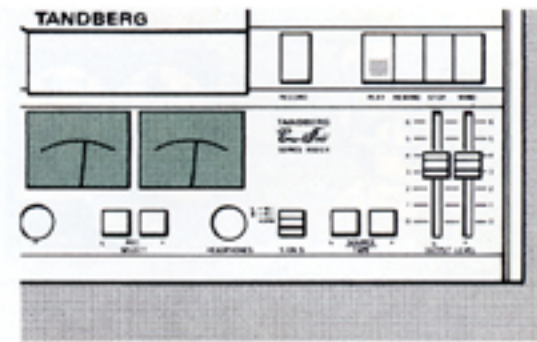

3. Set the desired program level from each channel with the appropriate OUTPUT LEVEL (L or R) knob.
4. To end the playback, depress the STOP button.

During playback of a program with a high content of loud high tones, the meters will read less than 0 dB, even if the program has been recorded at this level. This is quite normal, and is a result of the higher tones being pre-emphasized during recording. The corresponding de-emphasis in playback conforms to an international standard. The difference between the meter readings in recording and playback will be most noticeable at low tape speed.

Use as a microphone preamplifier

Stereo

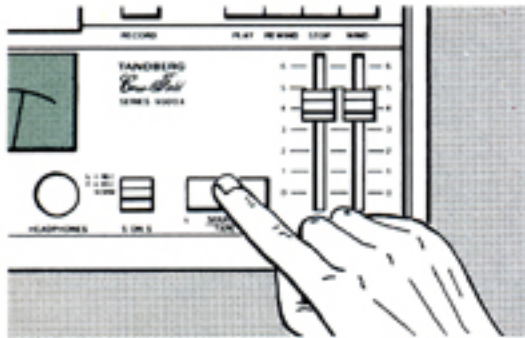

Stereo playback is performed in the same way as mono playback except that step 1 should read: Depress both SOURCE/TAPE buttons. The program from channels L and R will then be fed separately to the respective outputs.

Mono

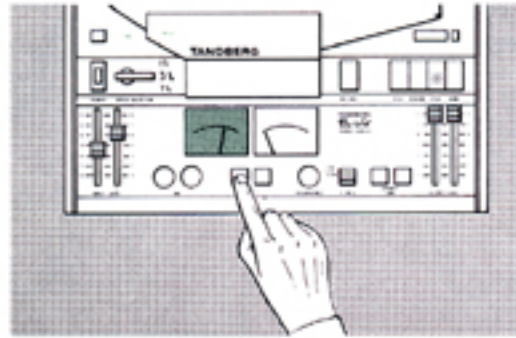

1. Plug a microphone into one of the MIC sockets (or one in each MIC socket).
2. Depress either one of the REC SELECT buttons to feed the microphone program to both channels.
3. Ensure that both SOURCE/TAPE buttons are out.
4. Set OUTPUT LEVEL L and R to maximum.
5. Adjust the program level from the microphone with the corresponding INPUT LEVEL control (L or R, or both if two microphones are used).

Stereo

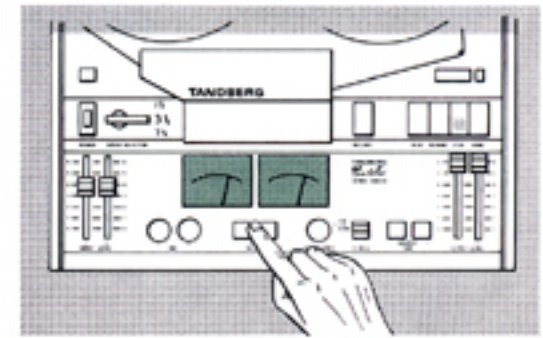

1. Plug microphones into both MIC sockets. Make sure that the microphone placed to the left of the sound source is connected to MIC L, and the other microphone to MIC R.
2. Depress both REC SELECT buttons.
3. Ensure that both SOURCE/TAPE buttons are out.
4. Set OUTPUT LEVEL L and R to maximum.
5. Adjust the program level from the microphones with INPUT LEVEL and R.

To avoid acoustical feed-back, endeavour to place the microphones in a position where the sound from the speakers does not enter direct.

Sound-on Sound recording

The Sound-on-Sound recording technique allows a program played back from one track to be mixed with another program and re-recorded on another track on the same tape. With this technique you can add your own voice to a recording of an orchestra, you can sing in multiple voices by adding one voice after the other, or you can play many instruments, forming a band with yourself as the only musician. The Sound-on-Sound technique can also be used for language studies. (See page 16).

It will usually be necessary to make a test of the Sound-on-Sound recording first. Listen in headphones and adjust the level with the OUTPUT LEVEL L and R. You will hear the original program when both SOURCE/TAPE buttons are out, and the recorded Sound-on-Sound program played back when the SOURCE/TAPE button for the channel used for recording is depressed. The person playing or singing into the microphones must listen to the source program in order to keep in synchronism with the original program. The monitoring of the Sound-on-Sound program played back from tape must be made by another person.

Monitoring of source - Recording on channel R

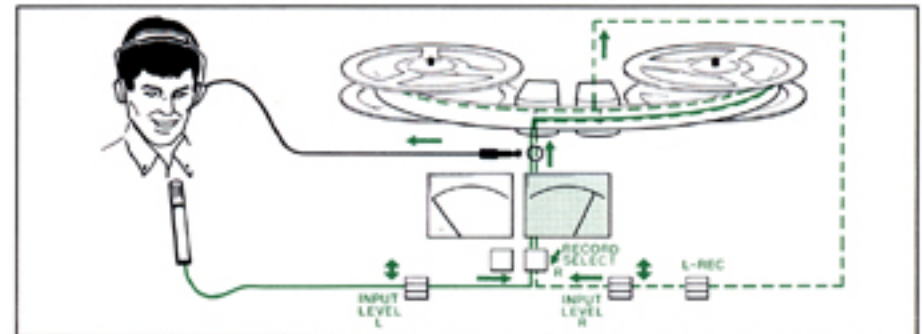

The first (original) program is recorded in the normal way. Assuming that this program is already existing on the left channel, the Sound-on-Sound recording is carried out as follows:

1. Depress REC SELECT R. The right hand meter is then illuminated, indicating that this channel is prepared for recording.
2. Set the S ON S switch to position L → REC.
3. Feed the new program into one of the L inputs and adjust the level with INPUT LEVEL L.
4. Start the recording by depressing RECORD.
5. Adjust the level of the program played back from channel L with INPUT LEVEL R.
6. If necessary, readjust INPUT LEVEL L and R to obtain the desired ratio of the two programs and correct indication on the record level meter (0 dB).
7. To end the recording, depress the STOP button. Always set S ON S switch back to position NORM when the Sound-on-Sound recording has been completed.

Monitoring of source - Recording on channel L

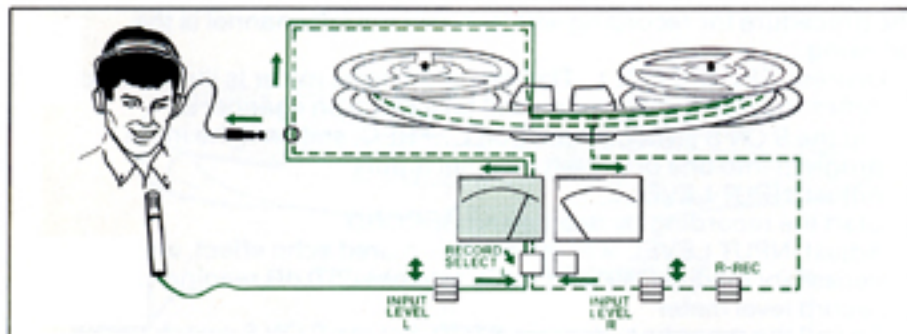

If the original program has been recorded on the right hand channel, the Sound-on-Sound recording is performed in the following way:

1. Depress REC SELECT L. The left hand meter is then illuminated, indicating that channel L is prepared for recording.
2. Set the S ON S switch to position R → REC.
3. Feed the new program into one of the left (L) inputs, and adjust the level with INPUT LEVEL L.
4. Start the recording by depressing RECORD.
5. Adjust the level of the original program from tape with INPUT LEVEL R.
6. If necessary, readjust INPUT LEVEL L and R to obtain the desired ratio of the two programs, and simultaneously obtain the correct reading on the record level meter.
7. To end the recording, depress the STOP button. Always set the S ON S switch back to NORM, when the Sound-on-Sound recording has been completed.

Monitoring from tape

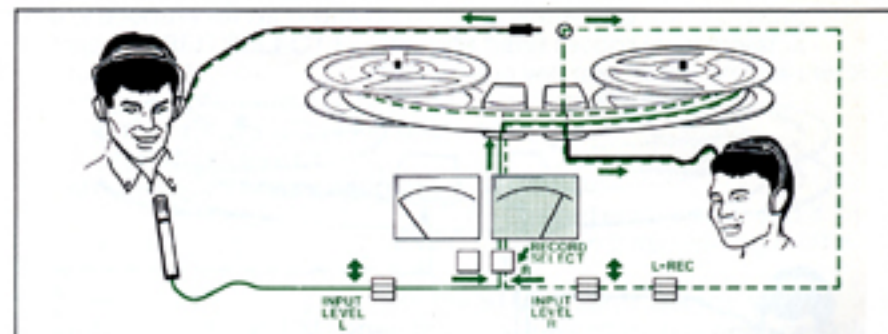

If it is desirable to monitor the recording from tape while recording (tape monitoring), an extra person is required for listening in headphones connected to the LINE OUT socket for the channel used for recording.

The person singing or playing the new program listens in headphones connected to the LINE OUT socket for the channel from which the original program is played back. He will then not hear his own voice in the headphones.

Both SOURCE/TAPE buttons must be depressed.

Echo

Left channel

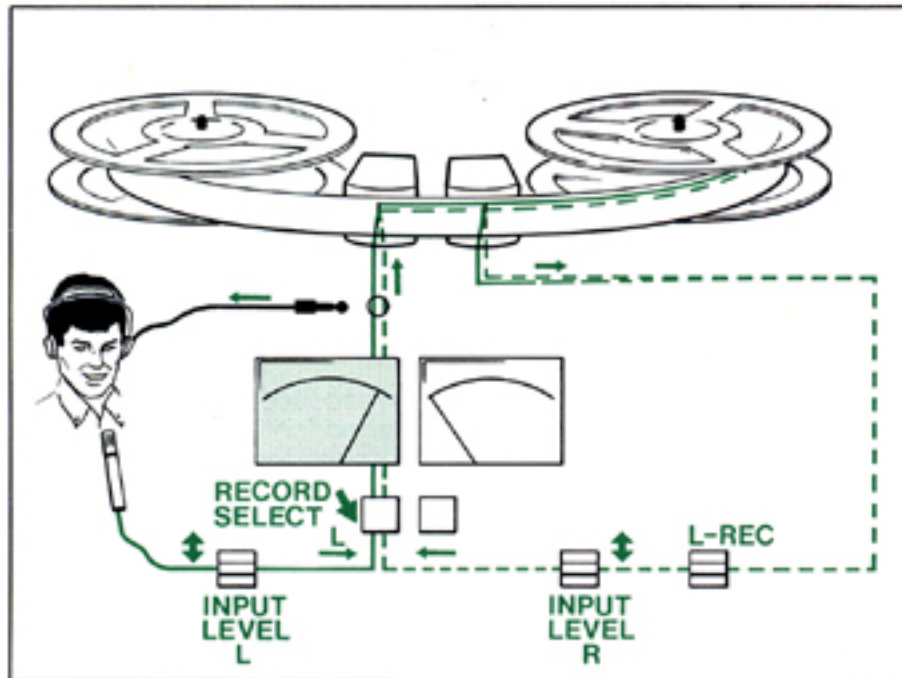

The procedure for recording with echo on the left channel is the following.

1. Depress REC SELECT L. The left record level meter is illuminated, indicating that the recording will take place on channel L.
2. Set the S ON S switch to position L → REC, and feed the input program into one of the left channel inputs.
3. Adjust INPUT LEVEL L.
4. Start the recording by depressing RECORD.
5. Adjust INPUT LEVEL R to obtain the desired echo effect, and if necessary readjust INPUT LEVEL L to obtain 0 dB reading on the record level meter.
6. To end the recording, depress STOP. Set the S ON S switch back to NORM, when the echo-recording has been completed.

It will be useful to make a test recording first. Listen in headphones, and adjust the level in the headphones with OUTPUT LEVEL L and R. Compare in source and tape monitoring that there is no impairment of the sound quality.

See also paragraph on monitoring on page 16

Right channel

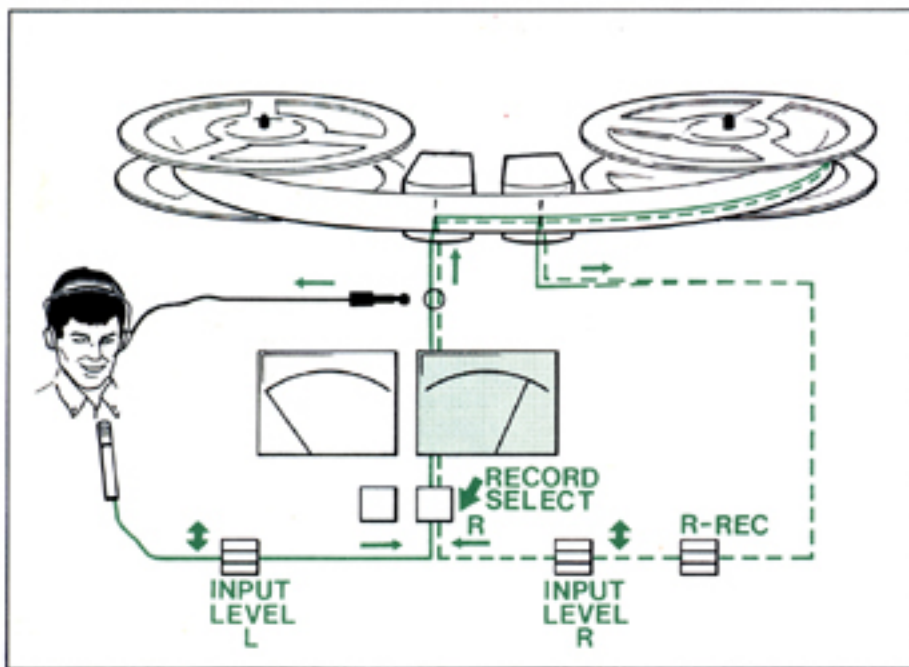

The procedure for recording echo on channel R is the following:

1. Depress REC SELECT R. The right hand record level meter is illuminated, indicating that recording will take place on channel R.
2. Set the S ON S switch to R → REC, and feed the input program into one of the left channel inputs.
3. Adjust INPUT LEVEL L.
4. Start the recording by depressing RECORD.
5. Adjust INPUT LEVEL R to obtain the desired echo effect, and if necessary readjust INPUT LEVEL L to obtain 0 dB reading on the record level meter.
6. To end the recording, depress the STOP button. Set the S ON S switch back to NORM, when the echo-recording has been completed.

Monitoring

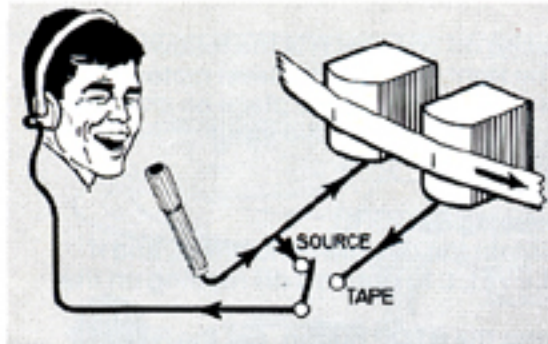

The purpose of the monitoring is to ensure that the best possible recording quality is obtained. This can be done by first listening to the program with its original quality as fed to the tape recorder (A-test or source monitoring), then listen to the program after it has been fed to the tape recorder, recorded, and played back (B-test or tape monitoring). If the recording has been made correctly, the sound quality before and after recording should not differ audibly. Use headphones or an auxiliary amplifier with a speaker for the monitoring.

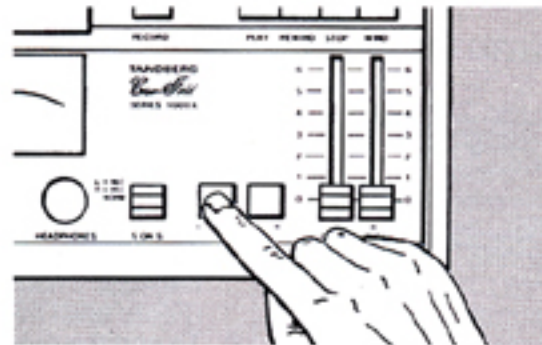

Mono

For source monitoring, both SOURCE/TAPE buttons must be out. For tape monitoring, depress the SOURCE/TAPE button for the channel used for recording. In both cases the program will be fed to the outputs of both channels.

Stereo

For source monitoring of the program, both SOURCE/TAPE buttons must be out. For tape monitoring, depress both SOURCE/TAPE buttons. The two channels of the stereo program are reproduced via the outputs of the left and right channels respectively.

Mixing

When recording, and when using the recorder as an amplifier, programs can be mixed or added. Only in mono (when only one of the REC SELECT buttons is depressed) can a program from one of the left inputs be mixed with a program from one of the right inputs with full control of the mixing ratio by means of the INPUT LEVEL controls. Programs from more than one input on either side will be added in the same ratio as applied at the inputs. In stereo, programs from the left inputs will add in the left channel in the same ratio as applied, and program from the right inputs will add in the right channel. The total program level in each one of the two stereo channels can still be individually controlled.

Language studies

For language studies use the Sound-on-Sound function. See the paragraph on Sound-on-Sound on page 12. The master program which is prerecorded on one channel is played back. The student listens to the program in headphones, and repeats the exercises into the microphone during the pauses in the program. Both SOURCE/TAPE buttons must be out. The master program and the student's response will be recorded on the other channel. When the lesson is finished, and the tape has been rewound to the beginning, the student will depress the SOURCE/TAPE button for the track which has just been used for recording and then start in playback. Both the master program and the student's response can then be heard in the headphones or in the speakers connected to an auxiliary amplifier.

Quarter-track recording and playback

This paragraph applies for the 4-track version of Series 9000 X only.

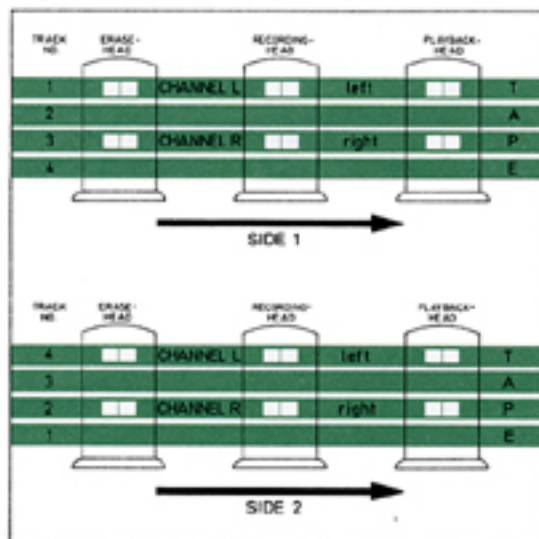

The location of the 4-tracks across the width of the tape is so that when starting from one end of the tape, track 1 will be recorded if REC SELECT L is depressed, and track 3 if REC SELECT R is depressed. When starting from the opposite end of the tape, recording will take place on track 4 with REC SELECT L depressed, and on track 2 with REC SELECT R depressed.

Playback

In mono playback of the 4-track tape, track 1 is selected by depressing SOURCE/TAPE L, and track 3 by depressing the SOURCE/TAPE R button when playing from one end of the tape. When playing from the opposite end of the tape, track 4 is selected by depressing SOURCE/TAPE L, and track 2 by depressing SOURCE/TAPE R.

Editing and splicing of tape

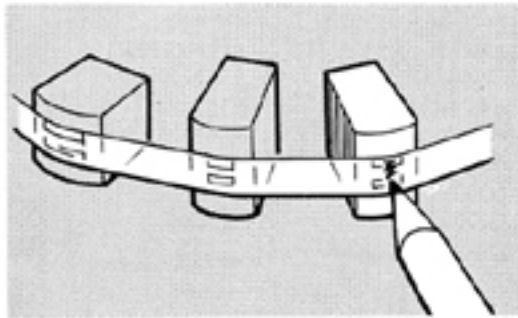

For splicing of tape, use a non-magnetic knife or scissors, and an adhesive tape specially made for splicing purposes. Recording of a program will not always occur in the same sequence as the program is later to be used. In that case, the tape must be edited, which means that it must be cut and spliced, so that the programs are presented in the desired sequence. When having found the place on the tape where it is desirable to cut it, stop the tape motion by depressing STOP. Remove the head covers by lifting them straight upwards. With a soft pen (felt or fibre) mark the tape at the playback head.



Pull the tape out, and cut it at the mark. Lay the two ends of tape to be spliced over each other with the same side facing up.

Cut the tape with scissors or a knife at an angle about 45° . Lay the tape ends against each other with no gap, or overlap and with the coated side of the tape (inside on the tape reels) facing down. Lay the splicing tape across the joint, parallel to the cut, and press firmly, squeezing out any air bubbles.

Cut off the splicing tape at both edges, cutting in a slight curve into the edge of the recording tape. This will prevent adhesive from the splicing tape from being deposited on the magnetic heads.

Note: Adhesive tape which is not expressly intended for splicing recording tapes, must under no circumstances be used

Degaussing

A marked increase of the background noise from the tape may indicate that the heads or other parts in the tape path need to be degaussed. However, Tandberg tape recorders are so designed that this will normally not occur unless the record level has been extremely high or magnetized tools have been used in the vicinity of the tape path. If required, degaussing should be carried out as follows:

Switch off the recorder. Remove the two head covers and move the degausser slowly past each one of the metal parts normally in contact with the tape. Then move the degausser slowly away from the recorder. Do not switch off the degausser until it is at least 3ft from the recorder.

Observe:

The heads and the metal parts in the tape path must under no circumstances be touched by the degausser as scratches are detrimental to the performance of the recorder and may result in loss of high frequency response and cause increased tape wear.

Cleaning of heads and tape path

It is imperative that those parts of the tape recorder that come into contact with the tape, are kept clean. Dust and other particles from the tape will inadvertently accumulate on the heads and tape guides and result in a reduced signal/noise ratio, impaired reproduction of higher tones, drop-outs, and increased wow and flutter.

For the cleaning, use cotton wool or a piece of flannel wrapped around a small stick and moistened with pure alcohol or benzine. The kit "Tandberg Professional Tape Head Cleaner" is specially intended for this use, and contains a small bottle of non-toxic and non-flammable liquid and a number of sticks wrapped with cotton.

Cleaning may be needed every 30–50 hours of operation or even more frequently if tapes of inferior quality are used.

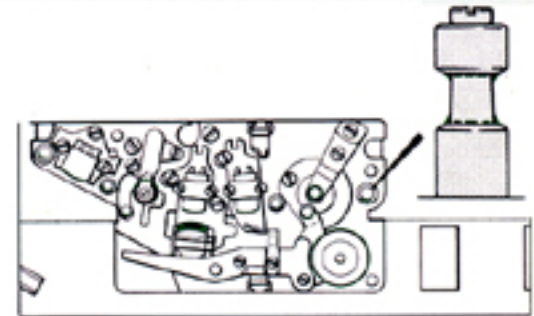

Clean all the parts that come into contact with the tape, paying particular attention to the sharp corners in the guide posts, where the accumulation of tape deposits is most pronounced. Do not use metal tools for cleaning, as they may cause scratches detrimental to the recorder's performance and may magnetize the components of the tape path. However slight the magnetism, this can cause partial erasure of your valuable tapes. Also be extremely careful not to displace the adjustable tape guides or heads. The pressure roller needs to be cleaned only if the tape motion is uneven or if there is a visible amount of deposits on the roller (four to six times a year will be satisfactory for even a frequently used machine). Brush the roller after the cleaning.

Note: Do not use solvents like acetone or trichlorethylene as these liquids will damage the heads

Function diagram

Application of Model 9000X	Setting of buttons and switches			Program to the various outputs	Notes
	Record controls	Playback controls	Sound-on-Sound switch		
Function					
Mono recording on channel L with monitoring			NORM	SOURCE monitoring: Left to all L and R outputs	Programs from left and right inputs are mixed
			NORM	TAPE monitoring: Left to all L and R outputs	
Mono recording on channel R with monitoring			NORM	SOURCE monitoring: Right to all L and R outputs	
			NORM	TAPE monitoring: Right to all L and R outputs	
Stereo recording with monitoring			NORM	SOURCE monitoring: Left to L outputs, right to R outputs	
			NORM	TAPE monitoring: Left to L outputs, right to R outputs	
Mono playback channel L			NORM	Left, to the outputs of both channels	
Mono playback channel R			NORM	Right, to the outputs of both channels	
Stereo playback			NORM	The channels separated (stereo)	
Mono preamplifier channel L			NORM	The same at all outputs	Programs from left and right inputs are mixed
Mono preamplifier channel R			NORM	The same at all outputs	
Stereo preamplifier			NORM	The channels separated (stereo)	
Sound-on-Sound			R→REC	Sound-on-Sound source monitoring to all outputs of both channels	Always connect program source to L inputs, and set the level with RECORD LEVEL L. Set the level of playback (original) program with RECORD LEVEL R
			L→REC		
Echo			L→REC	Echo to all outputs of both channels	Always connect program source to L inputs, and set the level with RECORD LEVEL L. Set the level of the echo program with RECORD LEVEL R
			R→REC		

Connecting plugs

Note: The plugs are shown from the wiring side.

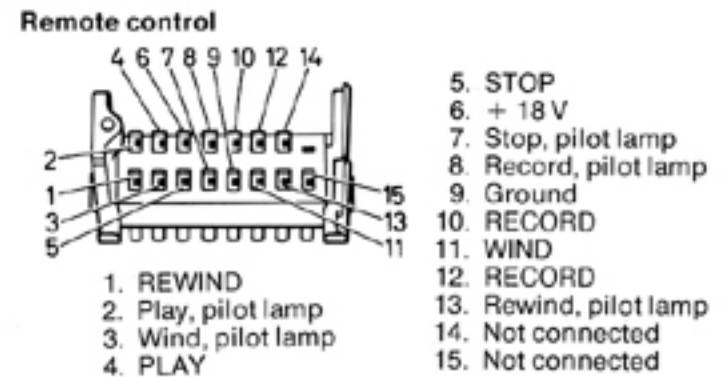
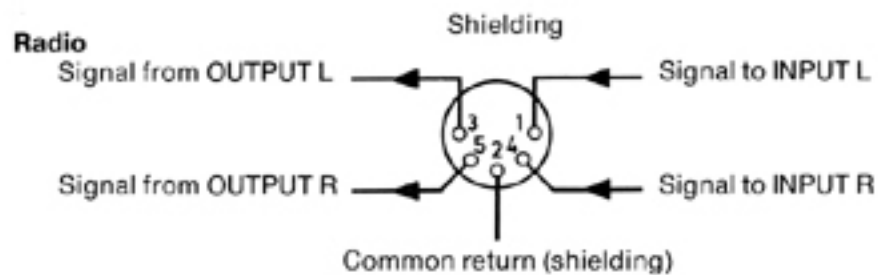
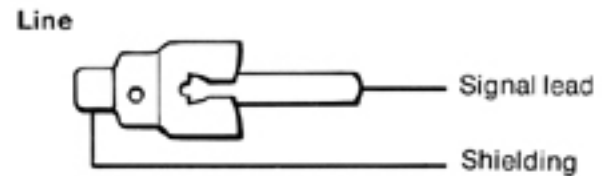
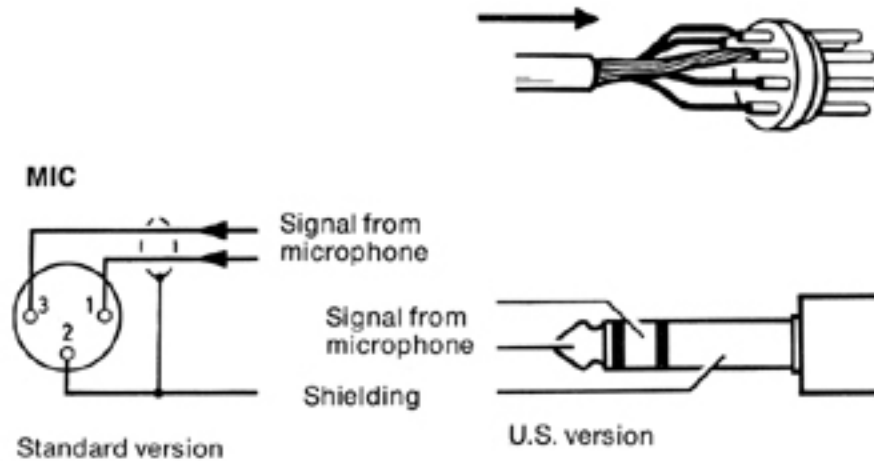

Block diagram

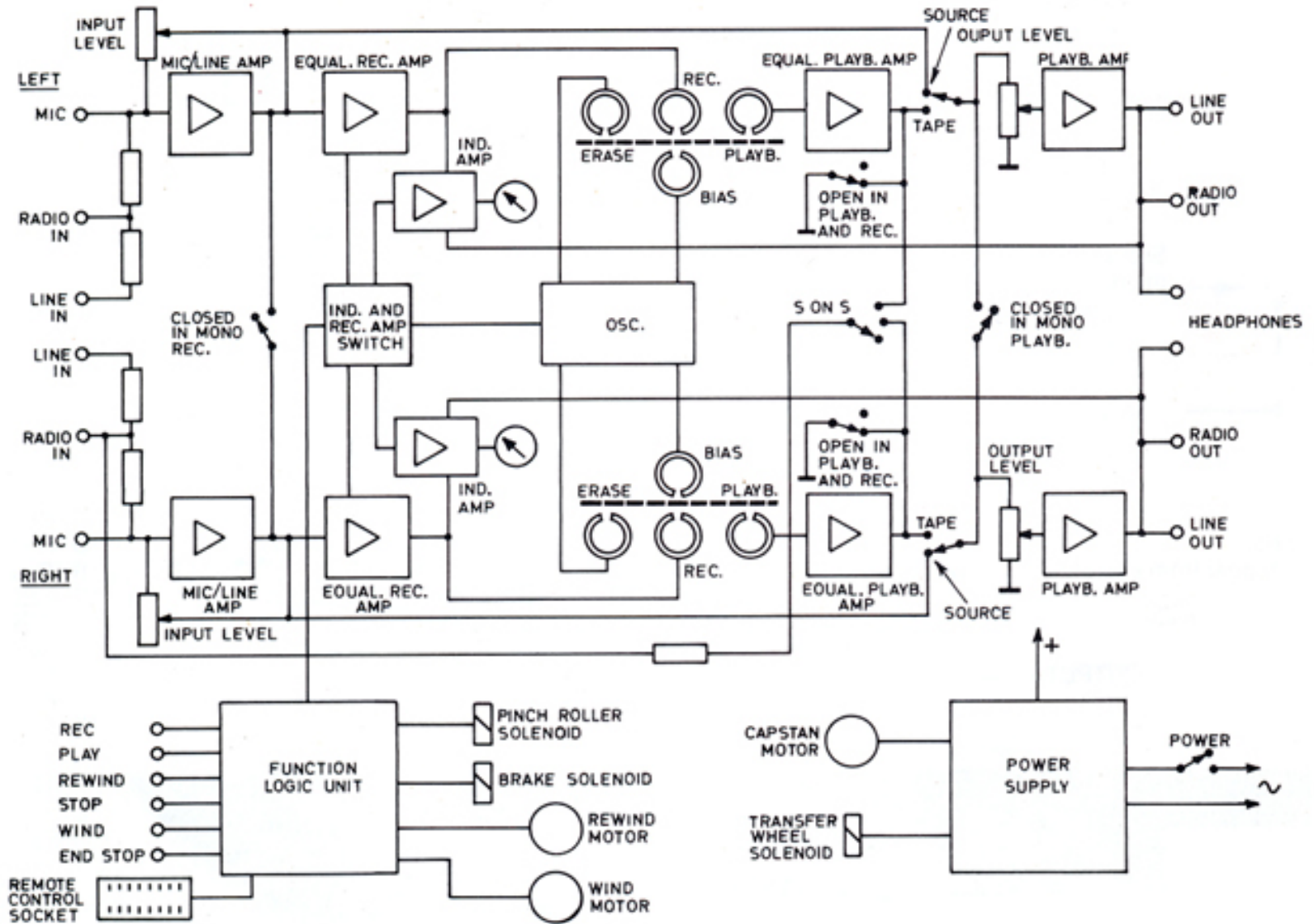

Technical specifications:

Power requirements: Standard Model: 230 V/50 Hz with rewiring possibility for 115 and 240 V. US Model: 115/60 Hz with rewiring possibility for 230 and 240 V.

Power consumption: 96 W.

Motors: Synchronous hysteresis capstan motor, separate reel motors.

Tape: Maximum reel size: 7". Preferably use LH-tape (Low Noise – High Output) for recording. If ordinary Low Noise tape is used, the optimum record level is –2.5 dB (at 3% distortion). Tapes with matt backing can be used.

Tape speeds: 7¹/₂, 3³/₄, 1⁷/₈ ips.

Speed tolerance: 1%.

Playing times:	1200 ft tapes	Stereo	Mono
	7 ¹ / ₂ ips:	2 x 32 min.	4 x 32 min.
	3 ³ / ₄ ips:	2 x 64 min.	4 x 64 min.
	1 ⁷ / ₈ ips:	2 x 128 min.	4 x 128 min.
	1800 ft tapes		
	7 ¹ / ₂ ips:	2 x 48 min.	4 x 48 min.
	3 ³ / ₄ ips:	2 x 96 min.	4 x 96 min.
	1 ⁷ / ₈ ips:	2 x 192 min.	4 x 192 min.

Winding times: 1200 ft. reel: 55 s.
1800 ft. reel: 75 s.

End-stop: Photo electric.

Meters: A peak reading meter for each channel indicates record level during recording. (0 dB = 3% distortion), and output level during playback. (RADIO: 0.7V, LINE OUT: 1V)

Inputs: MIC: Balanced input for dynamic microphone with an impedance of 200–700 ohms. Sensitivity 50 μ V. Maximum input voltage: 100 mV.

RADIO: Impedance 50 kohms. Sensitivity 5 mV. Maximum input voltage: 10 V.

LINE INPUT: Impedance 1 Mohm. Sensitivity 100 mV. Maximum input voltage: 15 V.

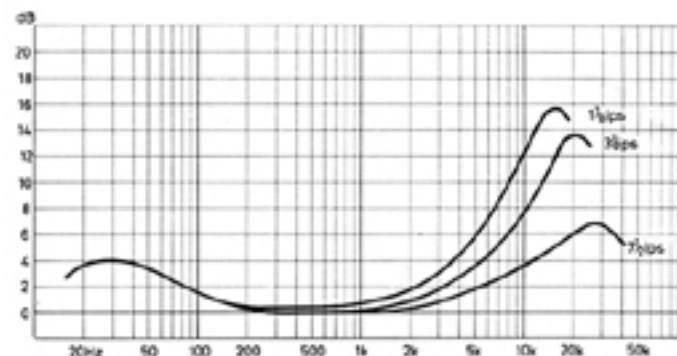

Record characteristics

Outputs: RADIO: Output impedance 5 kohms. Open circuit voltage 0.75 V.

LINE OUTPUT: Minimum load impedance: 200 ohms. Output voltage 1.5 V.

HEADPHONES: Minimum load impedance: 8 ohms. Output power 5 mW.

Distortion: In record amplifier at 0 dB: 0.5%.
 In playback amplifier at 0.75 V: 0.3%.
 From tape at 0 dB, 400 Hz: 3%.

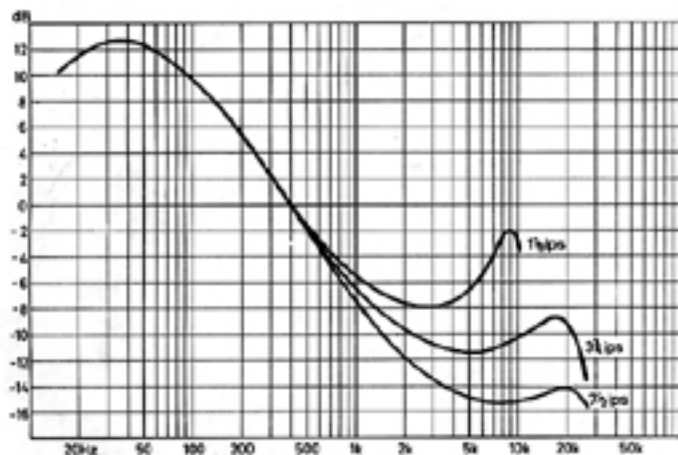

Playback characteristics

Frequency response:	± 2 dB	DIN 45511
7 1/2 ips:	40–22,000 Hz	40–25,000 Hz
3 3/4 ips:	50–16,000 Hz	40–18,000 Hz
1 7/8 ips:	50– 9,000 Hz	40–10,000 Hz
Amplifier mode	± 3 dB, 30–22,000 Hz	

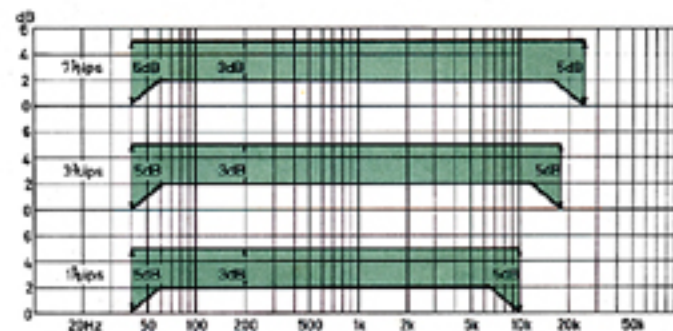

Frequency response with tolerance range as per DIN 45511

Wow:	W.R.M.S.	DIN 45511
7 1/2 ips:	0.07%	0.1%
3 3/4 ips:	0.14%	0.2%
1 7/8 ips:	0.28%	0.4%

Signal/tape noise with Tandberg tape or equivalent quality of LH tape:

	Quarter-track	half-track
IEC, A-curve 3% distortion	65 dB	67 dB
IEC, unweighted, R.M.S., 3% distortion	58 dB	58 dB
DIN 45511, Geräuschspannung	60 dB	62 dB
DIN 45511, Fremdspannung	56 dB	56 dB
Crosstalk suppression:	Mono: 60 dB.	Stereo 50 dB.
Weight: 15.5 kgs (34 lbs)		

TANDBERGS RADIOFABRIKK A/S

P.O.B 9, KORSVOLL OSLO 8 - NORWAY