

# Operating Manual

# Tandberg Series 3300X

## Contents

Introduction .....	2
Location of controls and connectors .....	3
Power supply .....	4
Tape .....	4
Vertical mounting .....	4
Preparation for use .....	5
Connections .....	5
Microphone .....	5
Stereo amplifier .....	5
Headphones .....	6
Copying of tape .....	6
Recording .....	6
Mono .....	6
Stereo .....	7
Program monitoring during recording .....	7
Playback .....	8
Mono .....	8
Stereo .....	8
The recorder used as a microphone amplifier .....	8
Mono .....	11
Stereo .....	11
Combined playback/amplifier function .....	9
Sound-on-sound .....	10
A-test .....	10
B-test .....	11
Mixing .....	11
Mono .....	11
Stereo .....	11
Language learning .....	12
Echo .....	12
Flying start – playback to recording .....	13
Program editing .....	13
Four track recording and playback .....	14
Degaussing of heads and tape path .....	14
Tape splicing .....	15
Automatic stop .....	15
Maintenance .....	16
Inspection .....	16
Cleaning .....	16
Connection plugs .....	17
Microphone TM6 .....	17
Function table .....	18
Technical specifications .....	19

# Tandberg Series 3300 X

Series 3300 X is a new and outstanding tape deck suited for the world's most discriminating markets in respect of quality and sound reproduction fidelity. The recorder is equipped with the revolutionary Tandberg crossfield which has extended the frequency range upwards and made the lower tape speeds more useful. The input dynamic range has been extended up to 66 dB, and simultaneously the input signal/noise level has been improved.

Series 3300 X has separate heads for recording and playback, rendering choice of A- or B-test monitoring and enabling sound-on sound and echo recording. The high sensitivity microphone inputs are intended for dynamic microphones with 200–700 ohm impedance. Separate inputs and outputs, located on the bottom cover, are provided for connection of receiver and amplifier. A fast rise, slow-decay (peak reading) record level meter on each channel indicates the program level applied to the record head. Stereo headphones for monitoring can be connected to socket on the top plate.

The recorder features flying start from record to playback mode or vice versa. Series 3300 X can be used in playback mode and as a microphone amplifier at the same time. This makes the recorder well suited as a central unit in a music and speech distributing system.



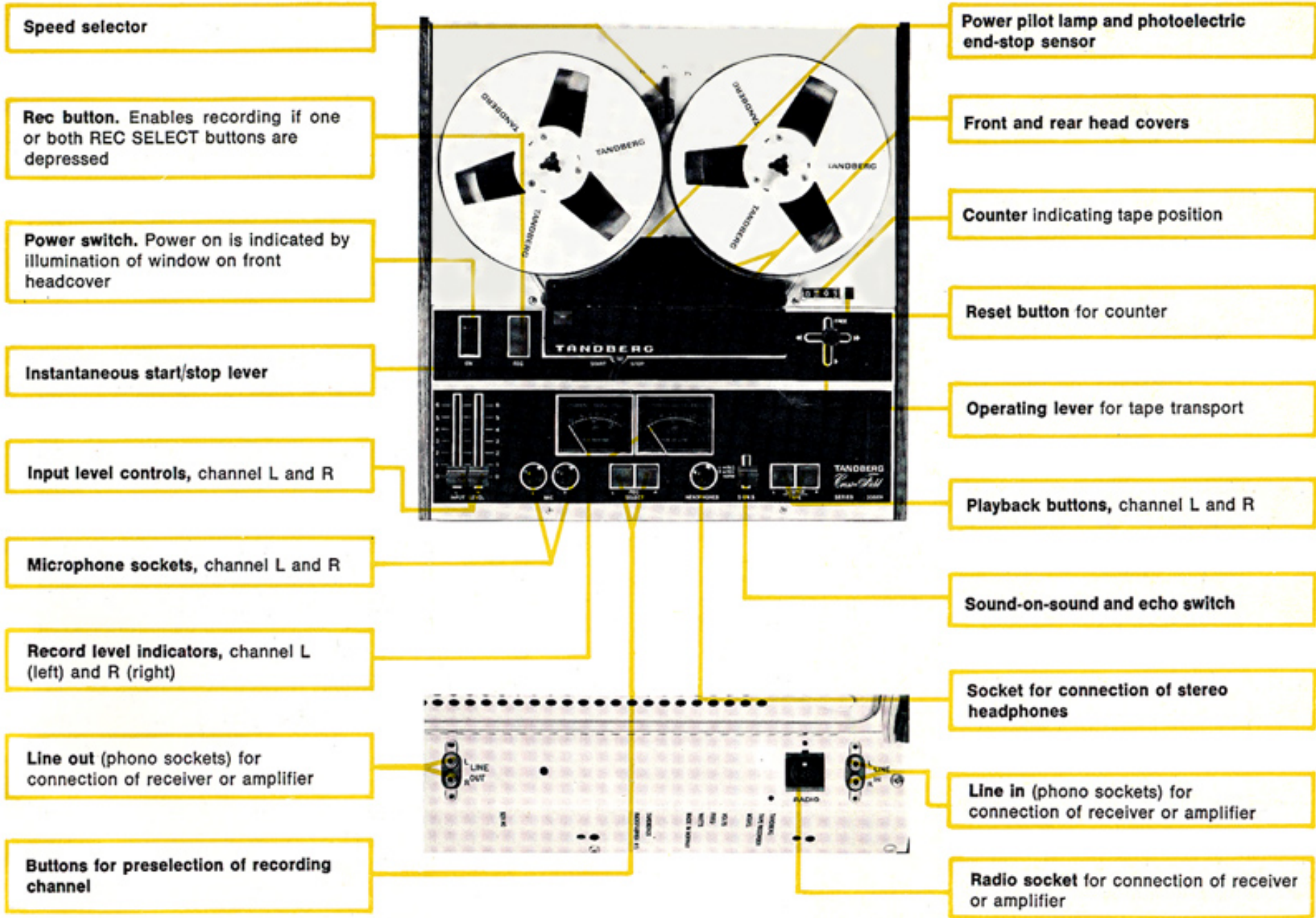

## Power supply

The tape recorder is set for operation on:  
US model: 115V/60Hz. Can easily be rewired for 230V or 240V.

Standard model: 230V/50Hz (English model: 240V/50Hz.) Can easily be rewired for 115V. To change the recorder from 60 to 50 Hz (or 50 to 60 Hz) operation, the motor pulley must be changed and the transformer rewired. We recommend that only a Tandberg service station or competent technician perform this service. Power consumption is 45 watts.

**Note:** Because of the photoelectric end stop sensor, the motor will not start until a tape has been properly inserted in the tape path. Wrong threading of tape may prohibit starting. If the tape has a transparent leader tape, the recorder will not start if the leader is situated in front of the photoelectric end stop sensor. To avoid this, cut away the transparent leader tape.

## Tape

Tandberg tape recorder series 3300 X is adjusted for recording on Tandberg Low Noise – High Output (LH) tape or equal.

For a given distortion (3 %) this type gives a 3 to 4 dB higher output level than ordinary Low Noise tape.

If the ordinary Low Noise tape is used for recording, the record level meter should not exceed the – 2.5 dB mark, if excessive distortion is to be avoided.

## Vertical mounting

The recorder can be used in horizontal or vertical position, or any intermediate angle. The front is equipped with rubber feet for vertical mounting.

To prevent the tape reels from falling off or being displaced during vertical operation, rotate the upper part of the turntable spindles  $\frac{1}{4}$  turn to lock the reels when having put the tape reels on the turntables.

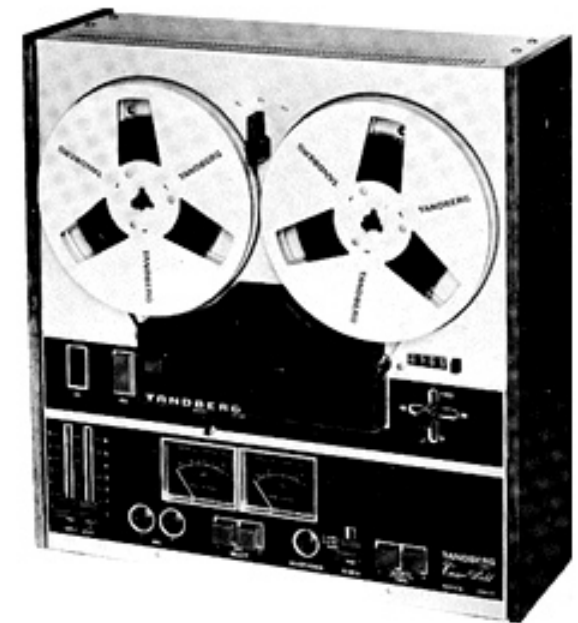



## Preparation for use

Connect the mains cable to a socket providing the correct voltage, and set the power switch to ON. The window on the front head cover is now illuminated and the recorder is immediately ready for use. Put a Tandberg LH tape or equal on the left hand turntable, ensuring that the reel runs anticlockwise when the tape is pulled out.

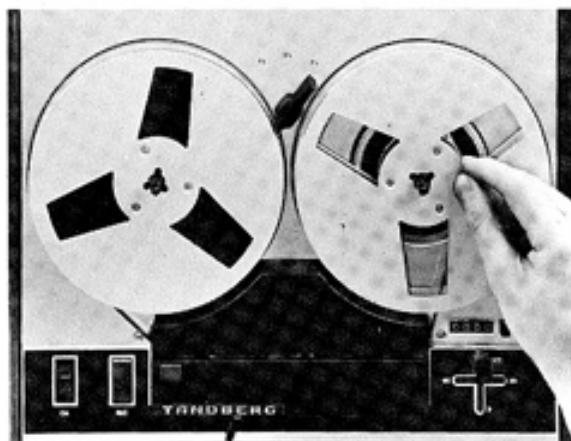

Thread the tape through the tape path and place the free end in the hub slot of the empty reel on the right hand turntable. Set the operating lever in FREE position to let the reels rotate independently. Rotate the right hand reel anticlockwise until the tape is firm.

Reset the counter. Set the S ON S switch to NORMAL and the tape speed selector for the desired tape speed. The best sound quality is obtained at  $7\frac{1}{2}$  ips, while  $1\frac{7}{8}$  ips gives longest playing time. See technical specifications page 19.

## Connections

### Microphone

For mono or stereo recording of live programs, connect one or two microphones to inputs MIC L and R on the front top plate.

#### Mono



#### Stereo

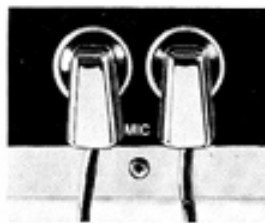

For mono recording, the microphone amplifiers for channels L and R are connected in parallel. Thus recording can take place on either channel, irrespective of which input the microphone is connected to. If an orchestra or some other sound source is to be recorded, place the microphone connected to MIC R to the right of the sound source, and the microphone connected to MIC L to the left of the sound source.

**Note:** Undesired mixing may occur if program is connected to RADIO or LINE IN sockets.

### Stereo amplifier/receiver

For stereo recording from receiver or amplifier, connect two phono leads from LINE IN L and R to the corresponding sockets TAPE OUT on the receiver or the amplifier. For stereo playback via receiver or amplifier, connect two phono leads from LINE OUT L and R on the recorder to TAPE IN on receiver or amplifier.

If it is desirable to use the DIN-socket for stereo recording and playback, connect a 5-pins DIN-cable from the RADIO socket on the recorder to the TAPE IN/OUT socket on receiver or amplifier.

This cable carries both the recording and playback signals.

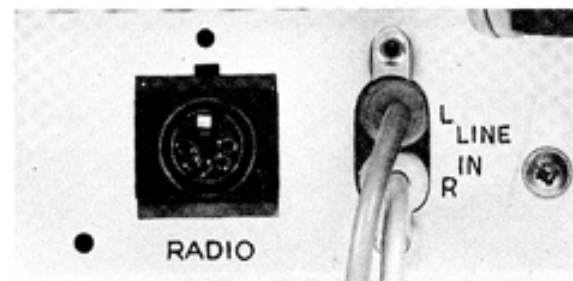

## Connections, continued

### Headphones

Connect stereo headphones to socket HEADPHONES. Use headphones with an impedance of minimum 100 ohms.

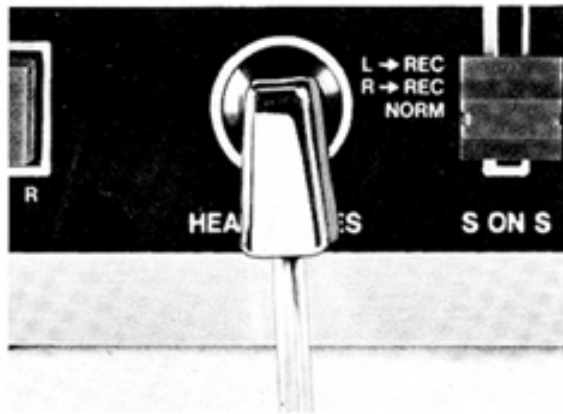

### Copying of tape

When copying stereo tapes, use two phono leads connected from LINE OUT L and R sockets on the playback recorder to the corresponding LINE IN sockets on the recording machine.

When copying mono tapes, only one of the leads is needed.

## Recording

### Mono

Connect external equipment as explained in connections page 5. Set START/STOP lever to STOP, and S ON S switch to the NORMAL position. Depress REC SELECT L button if recording is to be made on left (L) channel or REC SELECT R for recording on right (R) channel.



Depress REC button while moving operating lever to position ►. Left or right indicator is now illuminated. Adjust the record level with the INPUT LEVEL knob for the channel in question. The other INPUT LEVEL knob should be set to zero.

When using Tandberg LH tape or equivalent tape quality for recording, the meter should read 0 dB.

If ordinary low noise tape is used, the meter should read approximately -2.5 dB. A higher record level will increase the distortion. Only during very short passages can the recommended record levels be exceeded without causing audible distortion. A too low record level will make the tape noise more noticeable.

Reset the counter. Start the recording by operating the START/STOP lever.

To check the quality of recording, compare the recorded program with the original program, see paragraph on monitoring.

To end the recording, set the START/STOP lever to position STOP.

The START/STOP lever can also be used for shorter stops.

For longer stops, move the operating lever to center position. The REC button will then be released.

### Stereo

Connect the stereo program source to the tape recorder as explained on page 5. The procedure for stereo recording is the same as for mono, except for the following:  
Depress both REC SELECT L and R buttons. Both indicators will then be illuminated, and the program level for each channel is set with the corresponding INPUT LEVEL knob.

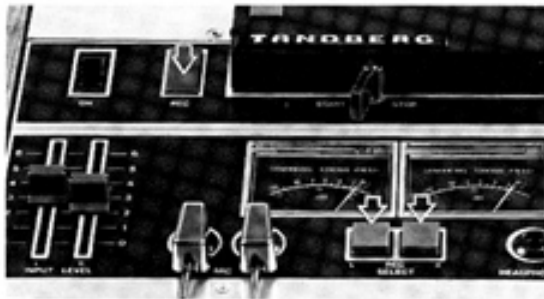

**Note:** It may be necessary to set the INPUT LEVEL controls in slightly different positions to obtain correct reading on both record level meters. This is quite normal because the meters are more accurate than the graduation of the controls.

## Program monitoring during record

The program can be monitored in two ways while recording is in progress:

1. Before it is recorded on the tape, called A-test (SOURCE/TAPE button released).
2. After recording (the program is delayed a fraction of a second compared to A-test program) via playback head and amplifier, B-test (SOURCE/TAPE button is depressed).

By alternately depressing and releasing the SOURCE/TAPE button(s), the quality of the recorded program can be compared with the quality of the input program. If the recording has been carried out properly at a tape speed adequate for the particular type of program, there should be no noticeable reduction of the sound quality when the SOURCE/TAPE button(s) is depressed.

### Mono

A-test of program is possible when both playback buttons are released (position SOURCE), B-test of recorded program when playback button for recording channel is depressed (position TAPE). In both cases the program is reproduced through outputs of both channels.

### A-test



**Note:** The S ON S switch must be in NORMAL position.

### Stereo

A-test of program when both playback buttons are released (position SOURCE), playback buttons are depressed (position TAPE). Program from channels L and R are fed to their respective outputs.

### A-test

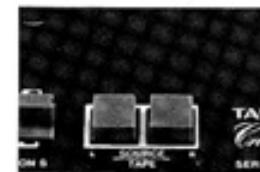

### B-test.



**Note:** The S ON S switch must be in NORMAL position.



## Playback

### Mono

Connect receiver, amplifier or headphones as explained on page 5–6. Use the counter to find the program to be played back. Set the START/STOP lever to STOP. Depress the playback button for the channel to be used to position TAPE and set the operating lever to position ►. Start playback by moving START/STOP lever to START.

The reproduced program is fed to the outputs of both channels. Playback loudspeaker level is adjusted by volume controls on receiver or amplifier. Return the operating lever to center position when playback has been finished.

The START/STOP lever can be used for shorter stops.

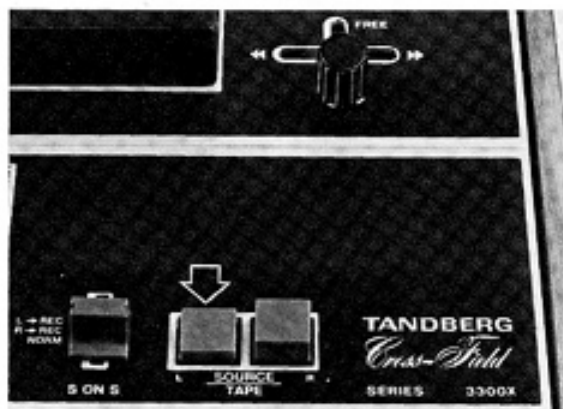

### Stereo

The procedure for stereo playback is the same as for mono playback, except that both playback buttons have to be depressed to position TAPE. The reproduced stereo program is fed to the outputs for the respective channels.

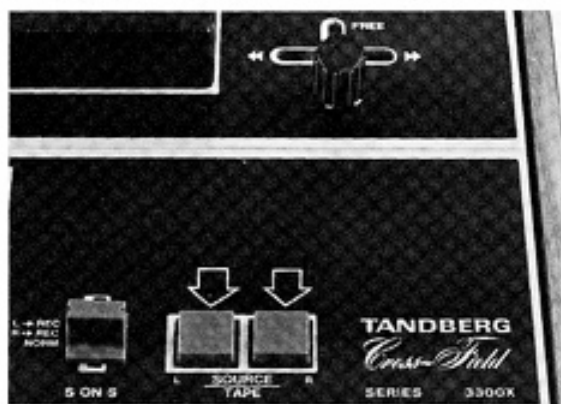

## The recorder used as a microphone amplifier

### Mono

Connect microphone as described on page 5. Depress the REC SELECT button for the channel to be used, and set the corresponding INPUT LEVEL knob in position 2–3.

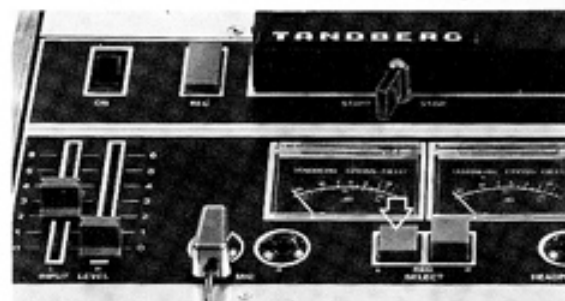

Leave the playback buttons unoperated (position SOURCE). The program is fed to the outputs of both channels, and the loudspeaker level has to be adjusted with the volume controls on the receiver or amplifier.





### Stereo

For use as a stereo microphone amplifier, depress both REC SELECT buttons, and set the INPUT LEVEL knobs in position 2-3. Leave the playback buttons unoperated (position SOURCE). Program from channel L input is fed to L outputs and from channel R input to R outputs. Adjust loudspeaker output levels with the volume controls on the receiver or amplifier.

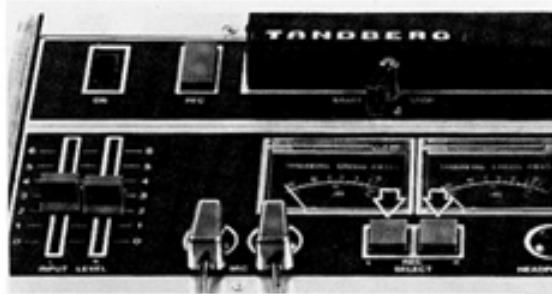

## Combined playback/ amplifier function

A program can be played back while simultaneously using the recorder as a microphone amplifier.

A consequence of this feature is that series 3300 X is well suited as a central unit in a music and speech distributing system.



Connect the recorder to a receiver or an amplifier with loudspeakers and set the S ON S switch to position L → REC when playing back from channel L and set to R → REC when playing back from channel R. In any case the microphone must be connected to the MIC L socket.

Set the START/STOP lever to STOP. Both playback buttons must be in unoperated (position SOURCE). Depress either one of the REC SELECT buttons. Move the operating lever to position ►. Start the playback by operating the START/STOP lever.

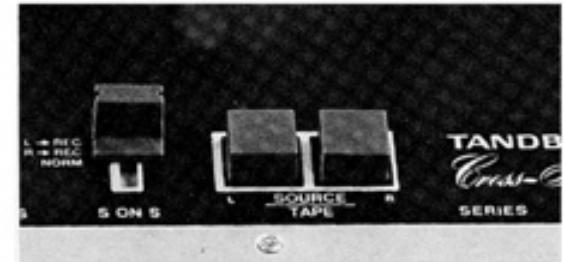

Both the program played back and the microphone program are reproduced via outputs of both channels.

Adjust the playback level by means of INPUT LEVEL R. When it is desirable to interrupt the music program to use the microphone for announcement, turn up INPUT LEVEL L while simultaneously turning down the music with INPUT LEVEL R until the desired balance between speech and music is obtained. After completion of announcement, set INPUT LEVEL L to zero while resetting the music level.

**Note:** REC button must not be depressed.

## Sound-on-Sound

Sound-on-Sound is a technique by which a program played back from one channel can be mixed with a program from an auxiliary source and recorded on the other channel.

### A-test

As shown in the figure, it is assumed that the original program is recorded on channel L. This program is played back and fed via internal connection to the input amplifier of channel R.

The following 10 steps should first be carried out as a test recording to establish the correct levels. When this procedure has been completed, rewind to the beginning of the original program and start the actual Sound-on-Sound recording.

1. Feed the new program to be superimposed on the original one to the input of channel L (MIC L).
2. Connect headphones to the socket HEADPHONES.
3. Set the S ON S switch to position L → REC to allow the program from channel L to be played back and re-recorded on channel R.
4. Depress REC SELECT R to prepare channel R for recording.

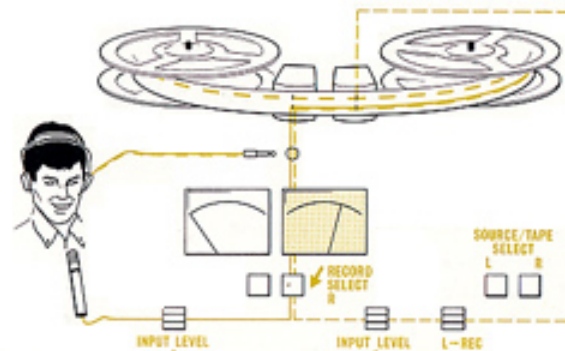
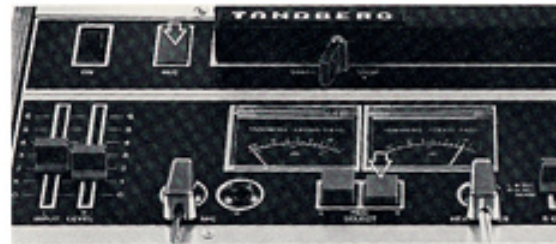

5. Depress the REC button and move the operating lever to ►.
6. Move the START/STOP lever to START.
7. Set INPUT LEVEL R to obtain a read-

ing a little below 0 dB on the record level meter.

8. Ensure that both playback buttons are out (position SOURCE).
9. Monitor the composite program in the headphones and set INPUT LEVEL L to obtain the desired balance between the original program (played back from tape), and the superimposed program (microphone program).
10. Check that the reading on the record level meter is 0 dB. If not, adjust both INPUT LEVEL L and INPUT LEVEL R accordingly while maintaining the balance between original and superimposed program.

Sound-on-Sound recording on channel R is accomplished in the same way except that steps 3 and 4 should read as follows:

3. Set S ON S switch to position R → REC to allow program from channel R to be played back and re-recorded on channel L.
4. Depress REC SELECT L to prepare channel L for recording.

**Note:** Don't forget to return the S ON S switch to NORMAL when the Sound-on-Sound recording is completed.



### B-test

To monitor the Sound-on-Sound program played back from tape while the program is being recorded, an extra person is needed (B-test). He will then be able to adjust the levels of the original and the superimposed programs to obtain the best possible result. The person singing or playing the program to be superimposed must listen to the original program in order to synchronize the new program. Use the procedure given for Sound-on-Sound recording in A-test with the following modifications of steps 2 and 8:

If channel R is to be used for recording:

2. Connect the headphones for the singing (or playing) person to LINE OUT L. Connect the headphones for the second person to LINE OUT R.
8. Depress both playback buttons (position TAPE).

Alternatively, if channel L is to be used for recording:

2. Connect the headphones for the singing (or playing) person to LINE OUT R. Connect the headphones for the second person to LINE OUT L.
8. Depress both playback buttons (position TAPE).

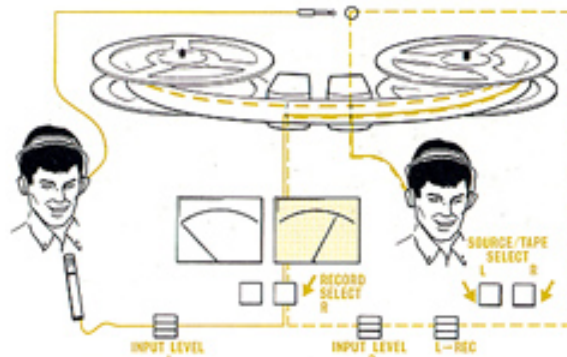

Notice that steps 9 and 10 are now instructions to the second person.

One program after the other can be added by making subsequent Sound-on-Sound recordings on alternate channels. No matter how good the tape recorder is, the background noise from the tape will, however, increase with each recording and set an upper limit for the number of programs that can be added.

## Mixing

### Mono

Mixing of two programs with full control of the individual program levels is possible in mono recording or when the recorder is used as a mono microphone amplifier.

To obtain this, connect one program source to one of the left inputs (L) and the other source to one of the right inputs (R).

Programs from more than one input (MIC, RADIO, LINE IN) of the same channel will mix in the ratio determined by the controls on the respective program sources. INPUT LEVEL L controls programs fed to L inputs, while INPUT LEVEL R controls programs fed to R inputs.

### Stereo

In stereo recording or when the recorder is used as a microphone amplifier, program fed to more than one input (MIC, RADIO, LINE IN) on each channel, will be mixed in the ratio determined by the controls of the respective program sources.

## Language learning

For language learning, use the sound-on-sound A-test technique. The following procedure assumes that the master program is prerecorded on left channel (track 1). This program is played back, mixed with the student response and re-recorded on right channel (track 3).

### CONNECTIONS AND LEVEL SETTINGS

#### Record

Connect headphones to the sockets LINE OUT L and R or to the socket HEADPHONES. Connect the microphone to MIC L. Set the START/STOP lever to STOP position and S ON S switch to position L → REC.

Operate REC SELECT R button and depress REC button while moving operating lever to position ►.

Leave both playback buttons in position SOURCE.

INPUT LEVEL R knob, controlling the level of transferred master program, should be set to position 3 approximately.

When speaking into the microphone, adjust INPUT LEVEL L for deflection up to 0 dB on right hand level meter. Set the counter to zero. Start recording by operating the START/STOP lever. Listen to the master program and repeat the exercises in the pauses.

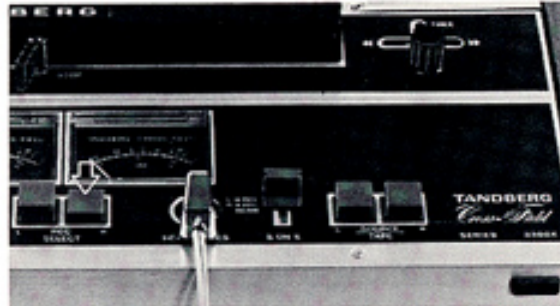

The master program as well as the student response is recorded on the student track (right channel). When recording has been completed, rewind to the beginning of the program, observe counter.

**Note:** Be careful not to operate the REC SELECT L button during recording to prevent erasure of the master program.

#### Playback

Depress channel R playback button (position TAPE) and listen to the mixed program (master and student) in headphones connected either to LINE OUT L and R or to HEADPHONES.

## Echo

The physical separation of the recording and playback heads can be utilized to produce echo effects during mono recording. The reverberation time is longest at the lowest tape speed.

Assume the echo to be recorded on channel L.

The following 10 steps should first be carried out as a test recording to establish the correct levels. When this procedure has been completed, rewind to the beginning of the tape and start the actual echo recording.

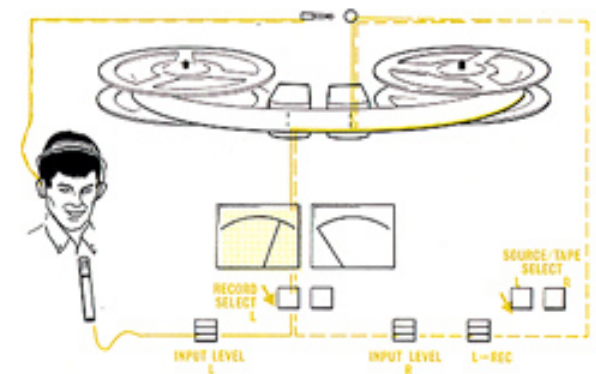

1. Feed the program to be recorded with echo into one of the L inputs.
2. Connect stereo headphones to socket HEADPHONES.
3. Set S ON S switch to L → REC.
4. Set START/STOP lever to STOP.



## Flying start - playback to recording

5. Depress REC SELECT L button.
6. Depress REC button while moving operating lever to ►.
7. Depress playback button L (position TAPE).
8. Adjust the record level of the input program with INPUT LEVEL L to obtain a reading somewhat below 0 dB on the left hand meter.
9. Start the recording by moving the START/STOP lever to START.
10. Set the echo level as desired with INPUT LEVEL R. Watch the record level meter of the channel used for recording to ensure that the echo does not cause the record level to exceed 0 dB. If necessary, readjust INPUT LEVEL L and R to obtain correct record level and desired echo.

**Note:** If the echo is turned up to much, the machine may oscillate and prohibit recording of the program.

An echo recording on channel R is carried out in exactly the same manner except that steps 3, 5 and 7 should read as follows:

3. Set S ON S switch to R → REC.
5. Depress REC SELECT R button.
7. Depress playback button R (position TAPE).

**Note:** Don't forget to return the S ON S switch to NORMAL when the echo recording has been completed.

For editing purposes or other reasons you may wish to start a new recording immediately following something already recorded on the tape. This can most easily be done by going direct from playback to recording utilizing the flying start feature.

### WARNING

Flying start recording implies a danger of accidental unwanted erasure of program and should be carried out with caution. Particularly observe step 1 in the following procedure:

1. Ensure that both REC SELECT buttons are up (released).
2. Depress the REC button while moving the operating lever to ►.
3. Start the tape by moving the START/STOP lever to START and listen to the program played back.
4. When you want to make the new recording, depress the REC SELECT button for the channel in question (both REC SELECT buttons if the program is in stereo).
5. To resume playback of the prerecorded program on the tape, release the REC SELECT button(s).

## Program editing

Programs are not always recorded in the same sequence as they are required for playback. It may therefore be necessary to edit tapes, i.e. cut and splice so as to present the program in the desired sequence.

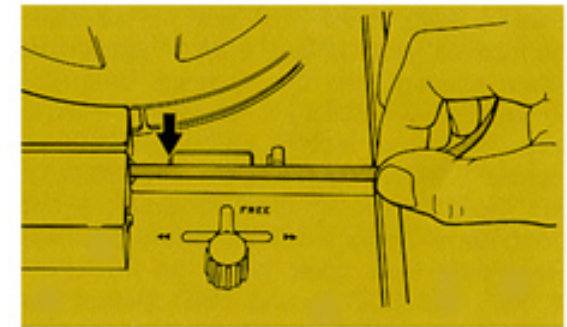

When a cutting point has been located during playback, stop the tape instantaneously by means of the START/STOP lever. Take hold of the tape at the right hand tape guide post, and pull it out to the inner edge of the cabinet. The operating lever must remain in position ►. The point at which the tape should be cut (see Tape splicing, page 15) is now at the left end of the counter window.

**Note:** Cutting and splicing for editing purposes must not be performed if there is a second program of value on some other track of the tape.

## Four-track recording and playback

This chapter applies for the four-track version of series 3300 X only.

### Recording

Recording can take place on four separate tracks equally spaced across the width of the tape with track 1 uppermost when playing back from one end of the tape, defined as side 1, and track 4 uppermost when playing from the opposite end, side 2. With REC SELECT L and REC buttons depressed and side 1 up, track 1 is recorded. When the tape has been run through, put the full reel on the left turntable and continue with the same buttons depressed. Recording then takes place on track 4. If REC SELECT R and REC button are depressed, track 3 will be recorded on side 1, and track 2 on side 2.

### Playback

In mono playback, side 1 of the tape gives a choice of tracks 1 or 3, depending on whether left or right channel playback button is depressed. Side 2 gives similarly a choice of track 4 or 2.

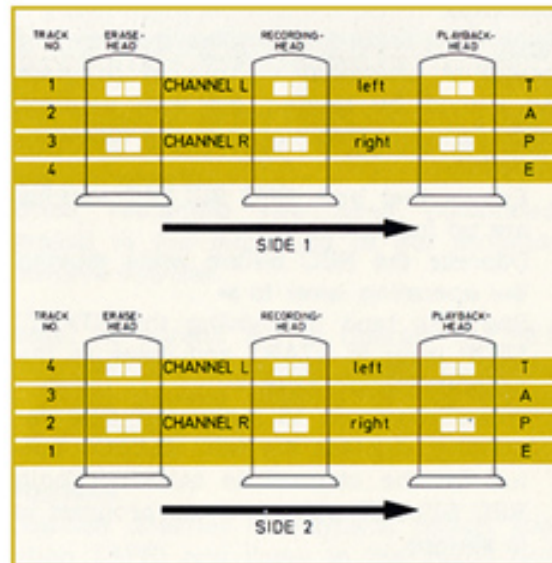

## Degaussing of heads and tape path

Degaussing should be performed every 100 hours of use in order to remove magnetic fields having occurred during the period of use.

Switch off the recorder. Remove the two head covers and move the degausser slowly past each one of the metal parts normally in contact with the tape. Then move the degausser slowly away from the recorder. Do not switch off the degausser until it is at least 3 ft from the recorder.

**Observe:** The heads and the metal parts in the tape path must under no circumstances be touched by the degausser as scratches are detrimental to the performance of the recorder and may result in loss of high frequency response and may increase tape wear.



## Tape splicing

For editing purposes, or if the tape has snapped, the ends must be spliced. Lay the ends of the tape over each other with the same side of the tape facing upwards. Cut the tape with scissors or knife (non-magnetic) at an angle of about 45 degrees.



Lay the tape ends against each other, shiny side up. Lay the splicing tape across the join, parallel to the cut, and press firmly, squeezing out any air bubbles.



Cut the splicing tape along both edges. The cut should curve slightly into the edge of the recording tape to prevent adhesive on the splicing tape from being deposited on the magnetic heads.

**Note:** Adhesive tape which is not expressly intended for splicing of recording tapes must under no circumstances be used.

## Automatic stop

A photoelectric end stop sensor located at the left hand tape guide post, operates a switch which stops the motor when the tape runs out or if the tape snaps.

If the tape reel is furnished with a transparent section of tape, the motor will also stop when this section is reached. This gives the possibility to stop the recorder at the end of the tape without tape running out.

The lamp for the photoelectric end stop operation, is also used as a «power on» indicator. Owing to the automatic end stop operation, the motor will not start until a tape has been correctly inserted into the tape path.

## Maintenance

When using the tape recorder, dust and particles from the tape will deposit on heads and guide posts. The coating will cause reduced signal-to-noise ratio and impaired treble reproduction, and may also cause drop-outs. Inspection and cleaning of the tape path should be performed regularly, before the symptoms become noticeable. It is highly recommended to use tape of the best quality because these tapes, in addition to giving a better sound reproduction, also leave less deposits and cause less wear of the heads.

Cleaning should be performed at intervals of 50 to 100 hours of operation, dependent of tape quality, temperature, amount of dust in the environments etc.

Cleaning and lubrication of motor and tape drive mechanism should only be performed at an authorized service station at intervals of approximately 300 hours of operation (corresponding to more than 4 months continuous operation).

### Inspection

Remove the front head cover by depressing the spring loaded buttons at both ends, and lifting the cover straight upwards. The operating lever should be in centre position. The back cover can be lifted off when the button on its rear side is depressed.

Inspect for contamination of the parts shown in the figure. Pay particular attention to the sharp corners of the tape guide post where deposits tend to settle (tape edge). Replace the head covers.

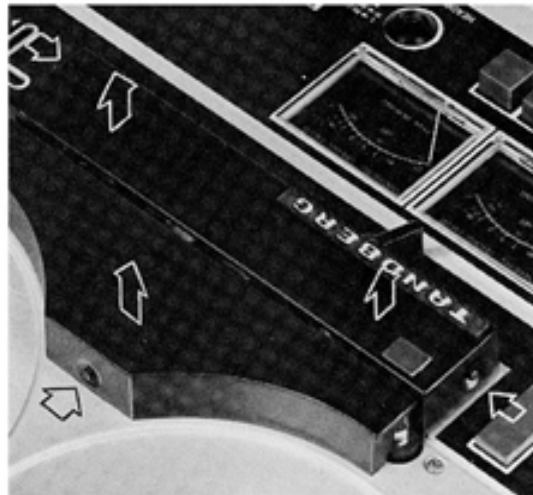

### Cleaning

The cleaning can be done with cotton wool or a piece of flannel, wrapped around a small stick, and moistened with pure alcohol or benzine. A kit intended for this purpose, «Tandberg Professional Tape Head Cleaner», containing a number of plastic pins with cotton (Q-tips) and a bottle with nonflammable cleaning liquid is available. Solvents such as acetone or trichlorethylene must not be used, as these may damage the heads. Clean at the spots indicated in figure.

The push pad pressing the tape against the tape rest must not be moistened, as this will upset the friction conditions. Cleaning of the push pad should be done with a dry brush.

1. Left fixed guide post.
2. Adjustable guide post.
3. Pressure pad plate.
4. Pressure pad.
5. Erase head.
6. Record head.
7. Playback head.
8. Bias head (crossfield).
9. Flutter roller.
10. Capstan.
11. Pinch roller.
12. Right fixed guide post.

**Note:** Care should be taken, not to disturb the position of heads or guide posts.

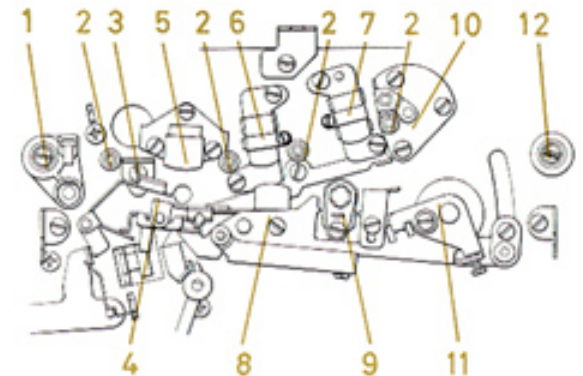



## Connecting plugs

Wiring diagrams for plugs to be connected to input and output sockets on series 3300 X.

### MIC – telephone plug

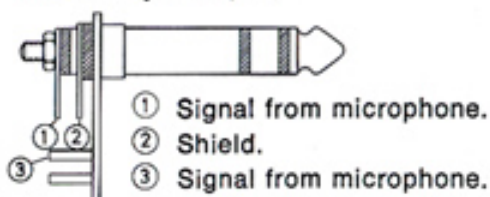

### MIC – DIN plug



Pins 1 and 2 are interconnected on the socket.

### HEADPHONES

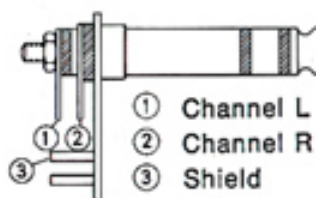

### RADIO

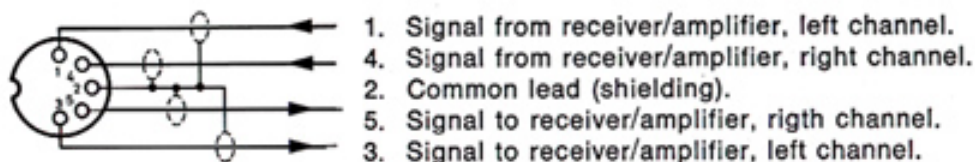

### LINE IN AND LINE OUT

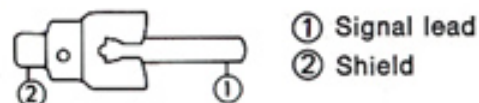

**Note:** The plugs are seen from the wiring side.

## Microphone TM6

Tandberg TM6 complete is a dynamic microphone of top quality, intended for high fidelity recording of speech and music. The TM6 display minimum sensitivity to wind and touch noises. This omnidirectional microphone features an extruded aluminum case.

The microphone is supplied with clip for floor stand attachment, table stand bracket and 13 ft (4 m) cable.

### Technical specifications

Frequency response: 50–15,000 Hz, +3 to –6 dB.

Sensitivity at 1000 Hz: 0.1 mV/ $\mu$ bar.

Impedance: 250 ohms.

Length: 7<sup>5</sup>/<sub>16</sub>" (185 mm).

Diameter (max.): 1<sup>5</sup>/<sub>16</sub>" (23,5 mm).

Weight: approx. 5.7 oz (160 g) with cable and plug.



## Function table

MODE OF OPERATION	POSITION OF BUTTONS AND SWITCHES				PROGRAM AT OUTPUTS	REMARKS
	REC SELECT	REC	TAPE/SOURCE	S ON S SWITCH		
Mono recording on channel L with program monitoring, AB-test.				NORMAL	A-test: Program to outputs on both channels. B-test: Program to outputs on both channels via tape.	L and R inputs will be mixed.
Mono recording on channel R with program monitoring, AB-test.				NORMAL	A-test: Program to outputs on both channels. B-test: Program to outputs on both channels via tape.	L and R inputs will be mixed.
Stereo recording with program monitoring, AB-test.				NORMAL	Stereo program to outputs on both channels in A- or B-test.	Playback buttons have to be operated simultaneously for AB-test.
Mono playback from channel L.				NORMAL	L program to outputs on both channels.	
Mono playback from channel R.				NORMAL	R program to outputs on both channels.	
Stereo playback.				NORMAL	Stereo program – channels separated.	
Mono amplifier – channel L.				NORMAL	Program to outputs on both channels.	
Mono amplifier – channel R.				NORMAL	Program to outputs on both channels.	
Stereo amplifier.				NORMAL	Stereo program – channels separated.	
Playback from channel L while using channel R as microphone amplifier.				L → REC	Both played back program and microphone program are reproduced via outputs on both channels.	Microphone must be connected to MIC L, and the level adjusted with INPUT LEVEL L. INPUT LEVEL R controls played back program.
Playback from channel R while using channel L as microphone amplifier.				R → REC	Both played back program and microphone program are reproduced via outputs on both channels.	Microphone must be connected to MIC L and the level is adjusted with INPUT LEVEL L. INPUT LEVEL R controls the played back program.
Sound-on-sound recording on channel L.				R → REC	A-test: Played back program to outputs on both channels. B-test: Played back program is monitored via LINE OUT R (master program) and mixed program via LINE OUT L.	Microphone must be connected to MIC L, and the level is controlled with INPUT LEVEL L. Played back program is controlled with INPUT LEVEL R. For monitoring in B-test, two persons are needed.
Sound-on-sound recording on channel R.				L → REC	A-test: Played back program to outputs on both channels. B-test: Played back program is monitored via LINE OUT L (master program) and mixed program via LINE OUT R.	Microphone must be connected to MIC L, and the level is controlled with INPUT LEVEL L. Played back program is controlled with INPUT LEVEL R. For monitoring in B-test, two persons are needed.
Echo recording on channel L.				L → REC	Echo program to outputs on both channels	Connect microphone to MIC L and the level is controlled with INPUT LEVEL L while echo level is adjusted with INPUT LEVEL R. Note: Do not set INPUT LEVEL R so high that echo becomes distorted.
Echo recording on channel R.				R → REC	Echo program to outputs on both channels	Connect microphone to MIC L and the level is controlled with INPUT LEVEL L while echo level is adjusted with INPUT LEVEL R. Note: Do not set INPUT LEVEL R so high that echo becomes distorted.



## Technical specifications

**Note:** The data below is guaranteed for all units.

### Mains voltage:

US model: 115 V/60 Hz. Can be rewired for 230 or 240 V.  
Standard model: 230 V/50 Hz (English model: 240 V/50 Hz). Can be rewired for 115 or 240 V.

### Power consumption:

45 watts.

### Motor:

2-pole shadowpole motor.

### Tape:

Maximum reel diameter 7". Tandberg Low Noise High Output (LH) tape or equal should be used for recording.

**Note:** If ordinary Low Noise tape is used, be aware that the meter deflection does not exceed  $-2.5$  dB mark to meet the 3% distortion claim.

### Tape speeds:

$7\frac{1}{2}$ ,  $3\frac{3}{4}$ , and  $1\frac{7}{8}$ .

### Speed tolerance:

$\pm 1\%$ .

### Forward and reverse winding:

1200 ft of tape, 7" reel: 1 min. 45 s.  
1800 ft of tape, 7" reel: 2 min. 10 s.

### Heads:

Erase head, record head, playback head, and bias head (Tandberg crossfield).

### Record level meter:

Moving coil peak reading meters. Deflection up to 0 dB corresponds to 3% tape distortion.

Rise time: Approximately 40 ms.

Meters are illuminated in record mode.

### Inputs:

Each channel has the following inputs:

1. Microphone input, unbalanced (MIC, telephone jack) for dynamic microphone with impedance below 700 ohms.  
Sensitivity:  $50 \mu\text{V}$ . Maximum input level: 100 mV.
2. Line input (LINE IN, phono socket).  
Impedance: 200 kohms. Sensitivity: 30 mV.  
Maximum input level: 15 V.
3. Radio input (RADIO, DIN-socket, pins 1 and 4).  
Impedance: 50 kohms. Sensitivity: 5 mV.  
Maximum input level: 10 V.

### Outputs:

Each channel has the following outputs:

1. Line output (LINE OUT, phono socket).  
Minimum load impedance: 100 ohms. Output level:  
A tape recorded with a 400 Hz signal to 0 dB meter reading will give 1.0 V when played back.
2. Radio output (RADIO, DIN-socket, pins 3 and 5).  
Impedance: 100 ohms. Output level: A tape recorded with a 400 Hz signal to 0 dB meter reading will give 1.0 V when played back.
3. Headphones output (HEADPHONES, telephone jack).  
Minimum load impedance: 100 ohms. Output level: A tape recorded with a 400 Hz signal to 0 dB meter reading will give 1.0 V when played back.

### Distortion:

Maximum distortion in recording amplifier at 0 dB meter reading: 0.5%.

Maximum distortion in playback amplifier: 0.3% at 1.0 V output level.

### Tape distortion:

A tape recorded with a 400 Hz signal at 0 dB level gives maximum 3% tape distortion when played back.

**Wow:**

W.R.M.S., maximum.

7 1/2 ips: 0.07 %

3 3/4 ips: 0.14 %

1 7/8 ips: 0.28 %

**Frequency response:**

Measured at 7 1/2 ips and 3 % tape distortion, using Tandberg tape or equivalent LH tape:

Referred to 400 Hz.

7 1/2 ips: 30–22,000 Hz ± 2 dB.

3 3/4 ips: 40–16,000 Hz ± 2 dB.

1 7/8 ips: 40– 9,000 Hz ± 2 dB.

Amplifier mode: 30–22,000 ± 3 dB.

**Crosstalk suppression:**

Measured at 1,000 Hz:

Mono > 60 dB

Stereo > 50 dB.

**Signal/tape noise:**

Measured at 7 1/2 ips and 3 % tape distortion, using Tandberg tape or equivalent LH tape:

	4-track	2-track
IEC, A-curve	64 dB	66 dB
IEC, unweighted R.M.S.	57 dB	57 dB



Recording curves.

**Dimensions:**

Length: 15 3/4" (40 cm). Height: 16 1/8" (41 cm).

Depth: 7" (18 cm).

**Weight:**

20 lbs (9.1 kg).

# TANDBERGS RADIOFABRIKK A/S

Kjelsåsveien 161 – Oslo – Norway

**DEALER:**



Kjelsås



Div. Kjeller



Div. Skullerud