

Huldra 8

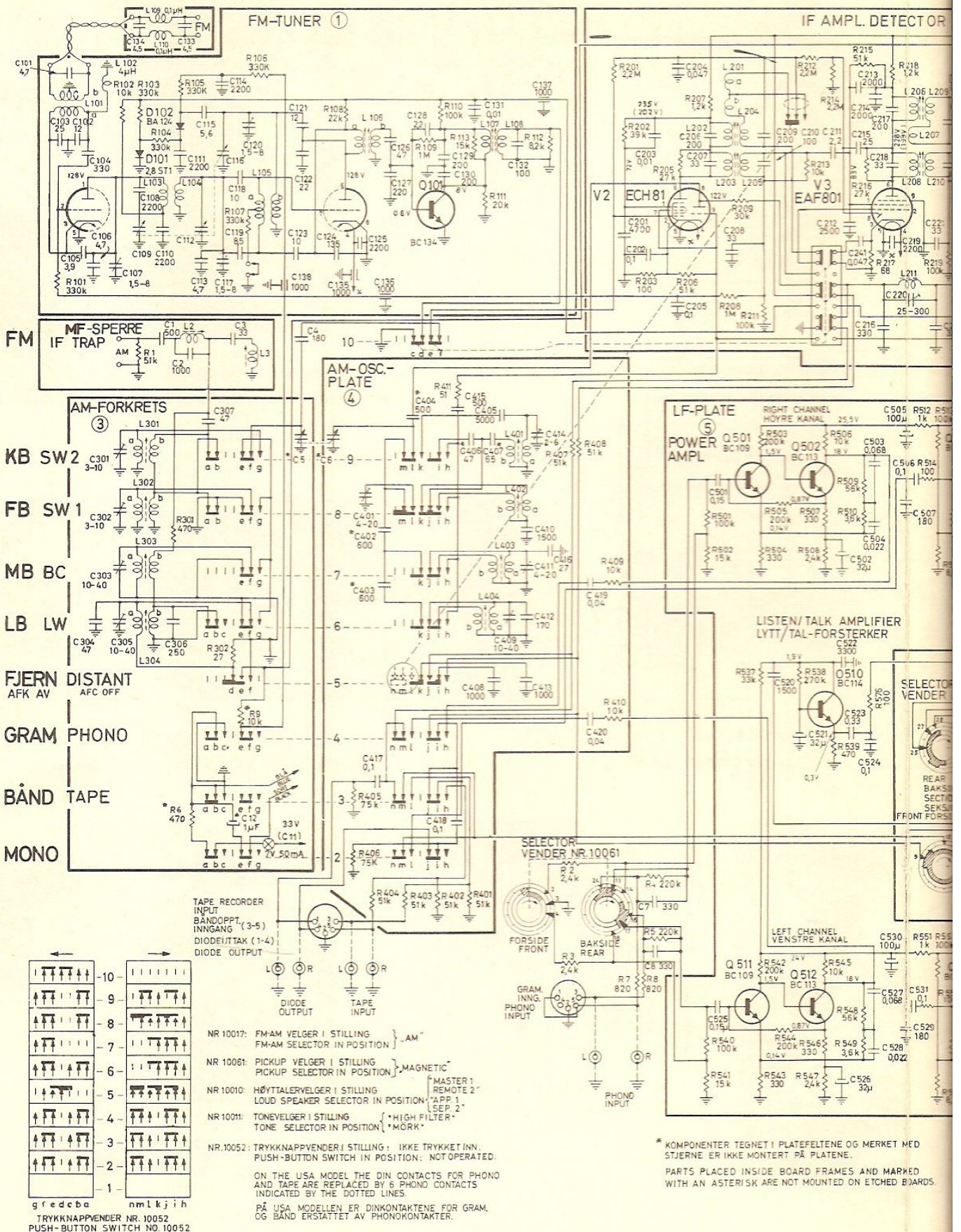

- NR 10017: FM-AM VELGER I STILLING } "AM"
- FM-AM SELECTOR IN POSITION
- NR 10061: PICKUP VELGER I STILLING } "MAGNETIC"
- PICKUP SELECTOR IN POSITION
- NR 10010: HØYTTALERVELGER I STILLING } "MASTER 1"
- LOUD SPEAKER SELECTOR IN POSITION } "REMOTE 2"
- (APP. 1.)
- NR 10011: TONEVELGER I STILLING } "HIGH FILTER"
- TONE SELECTOR IN POSITION } "MORK"
- NR. 10052: TRYKKNAPPVENDER I STILLING: IKKE TRYKKET INN.
- PUSH-BUTTON SWITCH IN POSITION: NOT OPERATED.

ON THE USA MODEL THE DIN CONTACTS FOR PHONO AND TAPE ARE REPLACED BY 6 PHONO CONTACTS INDICATED BY THE DOTTED LINES.

PÅ USA MODELLEN ER DINKONTAKTENE FOR GRAM. OG BÅND ER STATTET AV PHONOKONTAKTER.

* KOMPONENTER TEGNET I PLATEFELTENE OG MERKET MED STJERNE ER IKKE MONTERET PÅ PLATENE.

PARTS PLACED INSIDE BOARD FRAMES AND MARKED WITH AN ASTERISK ARE NOT MOUNTED ON ETCHED BOARDS.

IF AMPL. DETECTOR MF-PLATE ②

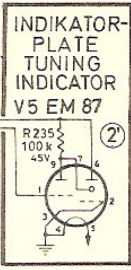
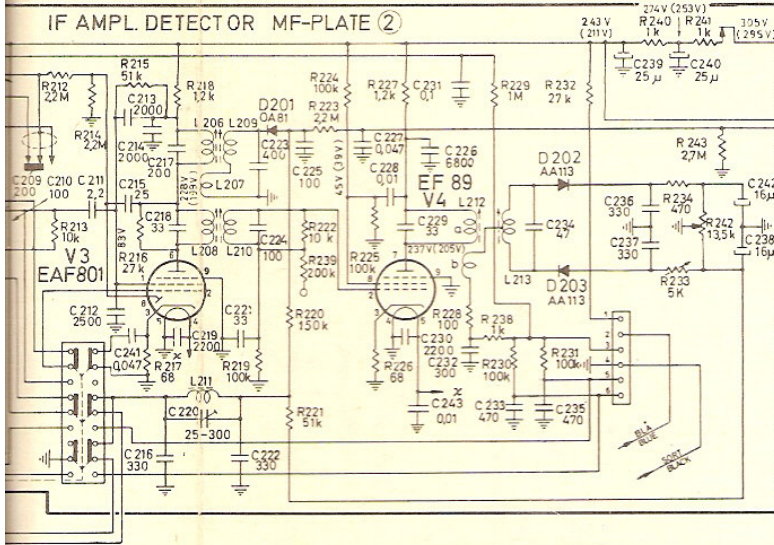

HULDRA 8

FRA SERIE NR. 433701
FROM SERIES

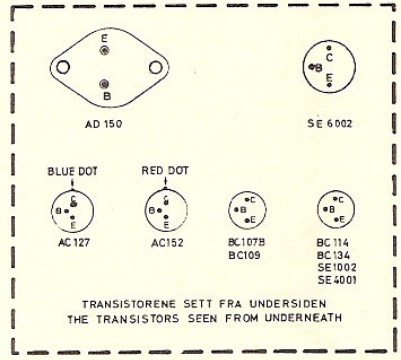
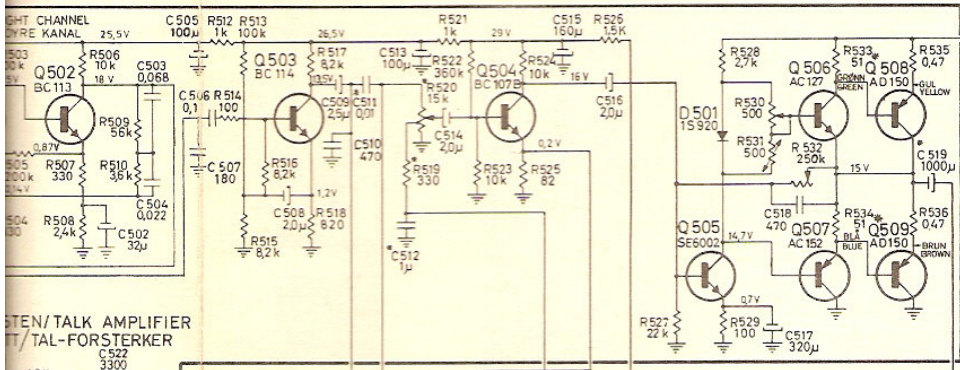
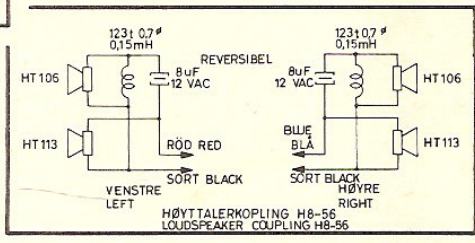

STEN/TALK AMPLIFIER
TAL-FORSTERKER

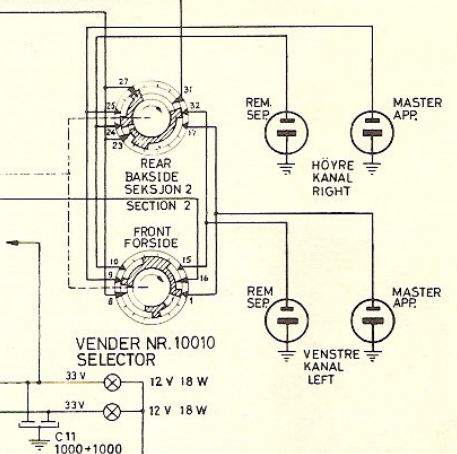
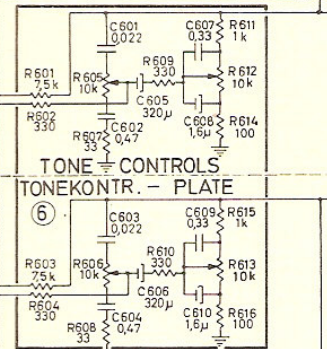
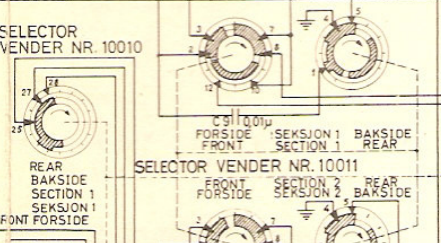
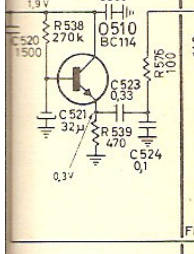

LEFT CHANNEL
VENSTRE KANAL

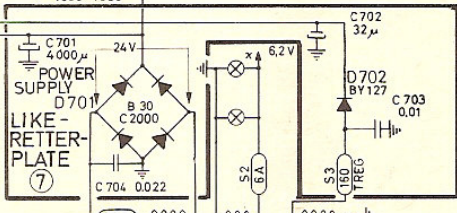
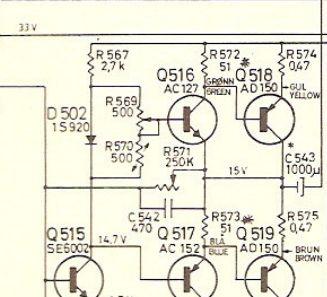
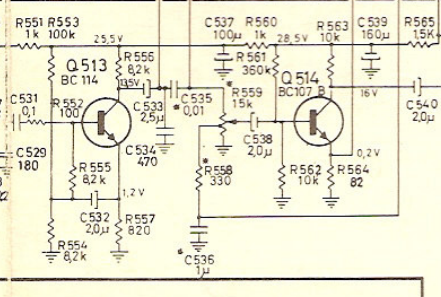
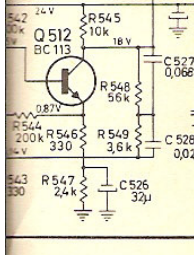

PLATEFELTENE OG MERKET MED
ERT PÅ PLATENE.
BOARD FRAMES AND MARKED
NOT MOUNTED ON ETCHED BOARDS.

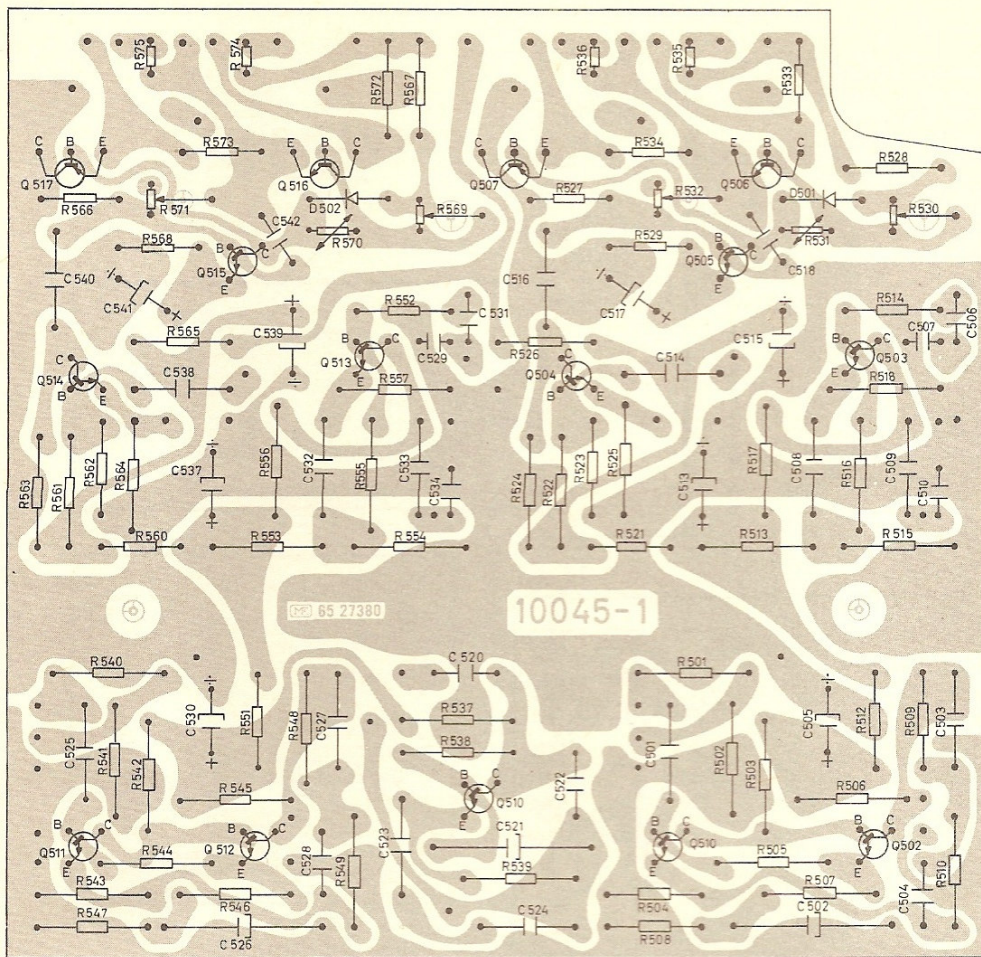

LF-platen sett fra foliesiden.
The power amplifier board seen from the printed side.

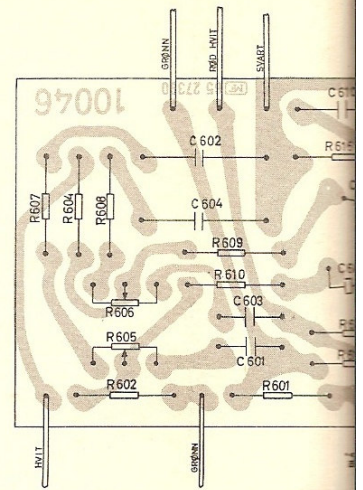

Tonekontrollplaten sett fra foliesiden.
The tone control board seen from the printed side.

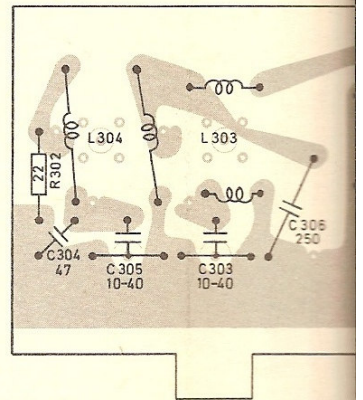

AM-forkrets-platen sett fra foliesiden.
The AM-tuner board seen from the printed side.

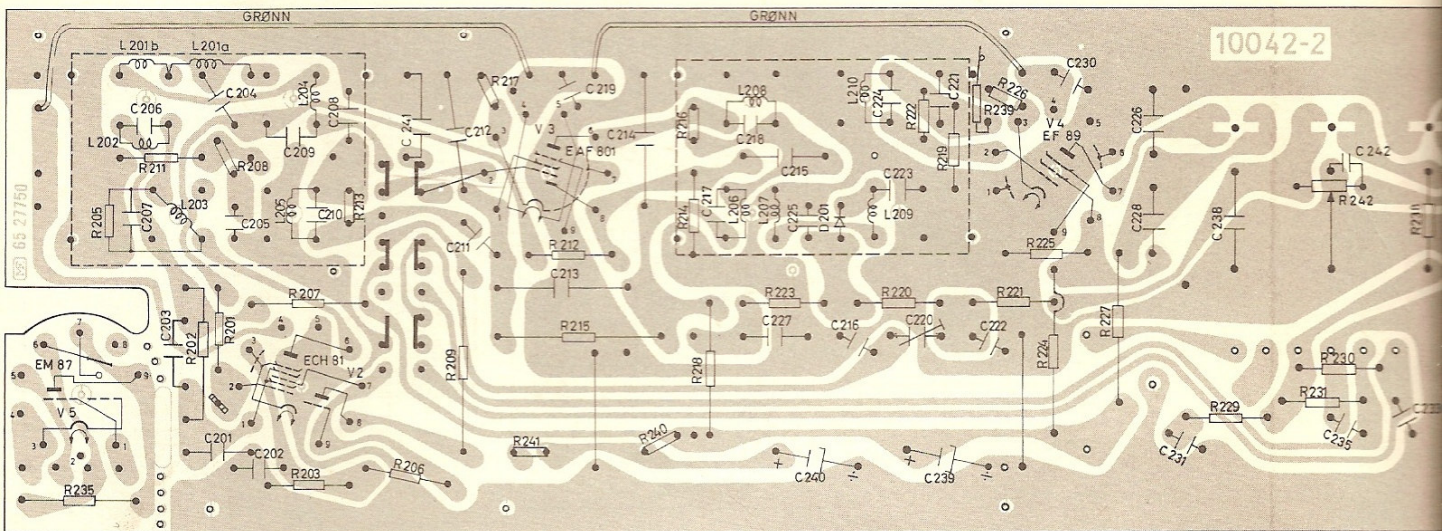

MF-platen sett fra foliesiden.
The IF-circuit board seen from the printed side.

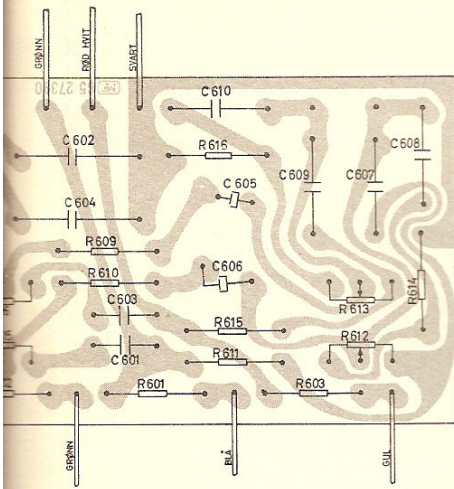

nekontrollplaten sett fra foliesiden.
control board seen from the printed side.

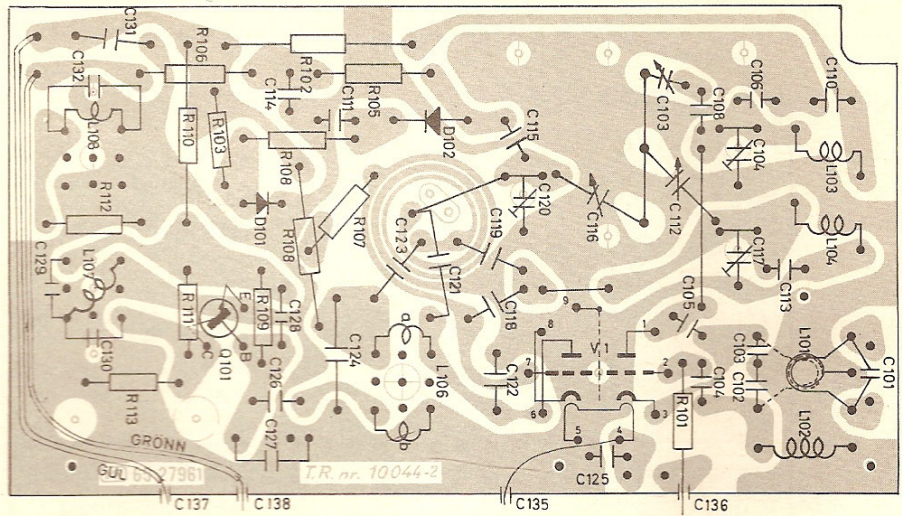

FM-platen sett fra foliesiden.
The FM-tuner board seen from the printed side.

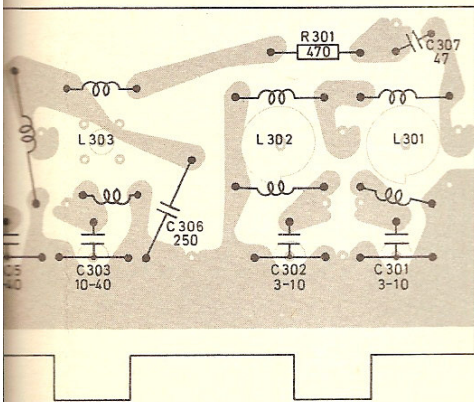

M-forkrets-plate sett fra foliesiden.
M-tuner board seen from the printed side.

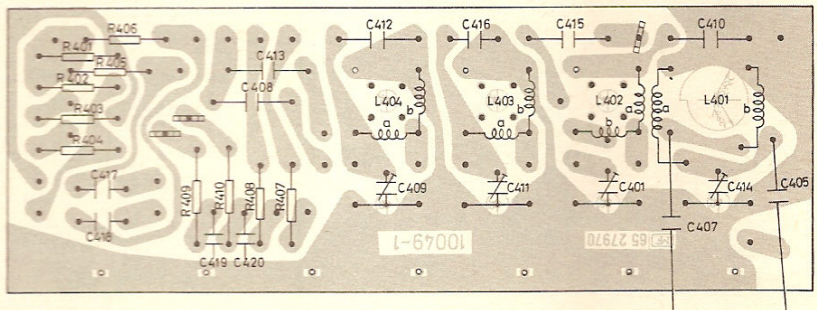

AM-oscillator-plate sett fra foliesiden.
The AM-oscillator board seen from the printed side.

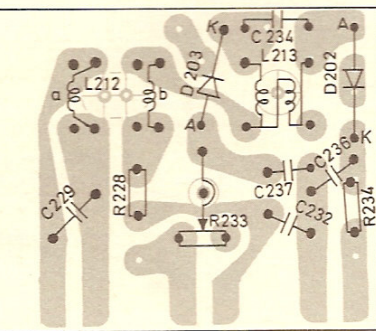
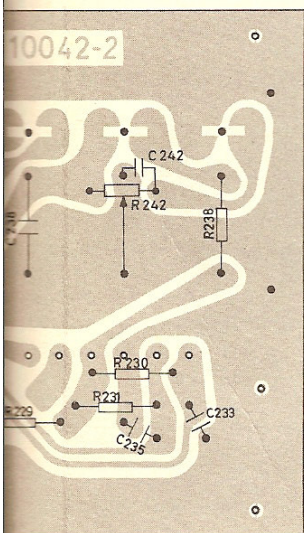

Detektorplaten sett fra foliesiden.
The detector board seen from the printed side.

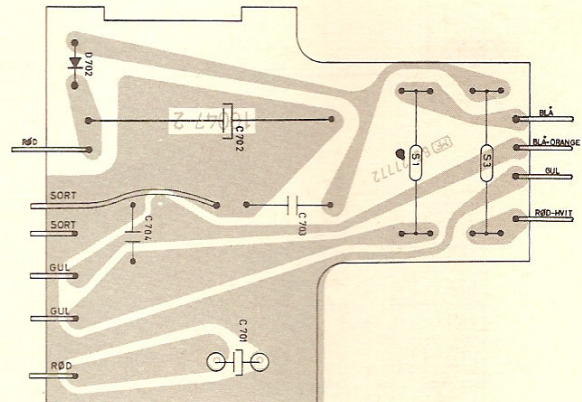

Likeretterplaten sett fra foliesiden.
The power supply board seen from the printed side.